

**Enhanced Techniques to Plan Rural Electrical Networks
Using the Reference Electrification Model**

by
Turner Cotterman

B.S., Electrical Engineering, Clemson University (2015)
Submitted to the Institute for Data, Systems, and Society
in partial fulfillment of the requirements for the degree of
Masters of Science in Technology and Policy

at the
MASSACHUSETTS INSTITUTE OF TECHNOLOGY

June 2017

© Massachusetts Institute of Technology 2017. All rights reserved.

Author
Institute for Data, Systems, and Society
May 23, 2017

Certified by.....
Jose Ignacio Pérez-Arriaga
Visiting Professor, Sloan School of Management
Professor, Electrical Engineering, Comillas University
Thesis Supervisor

Certified by.....
Claudio Vergara
Postdoctoral Associate, MIT Energy Initiative
Thesis Supervisor

Accepted by
Munther A. Dahleh
Professor, Electrical Engineering and Computer Science
Director, Institute for Data, Systems, and Society
Acting Director, Technology and Policy Program

Enhanced Techniques to Plan Rural Electrical Networks Using the Reference Electrification Model

by
Turner Cotterman

Submitted to the Institute for Data, Systems, and Society
on May 23, 2017, in partial fulfillment of the
requirements for the degree of
Masters of Science in Technology and Policy

Abstract

Although there have recently been many significant digital and technical advances in the electric power industry, rural electrification remains a pressing issue in the developing countries around the world. The International Energy Agency estimates that there are 1.2 billion people globally who lack access to electricity. Planning electrical networks to provide energy access to these primarily rural consumers is complicated by the lack of accurate data by electric utilities in these areas and the increased prevalence of microgrids and low-cost individual energy systems which challenges the traditional definition of energy services.

Advanced computational planning tools can allow planners and policymakers to take resource constraints, environmental considerations, interactions between off-grid and traditional grid extension projects, and many other factors into account when designing rural electrification policies and plans. The goal of this thesis is to contribute to the development and application of the Reference Electrification Model (REM), a decision support tool which can help planners design optimal electrical networks for rural electrification purposes.

In this thesis, I develop the functionalities of REM through several case studies. I also address the topics of estimating the electrification status of buildings and calculating the cost of upstream network reinforcements due to new load additions in the system. This research emphasizes the need for computational tools like REM to develop both feasible network designs as well as viable energy policies and regulations in order to advance efforts related to rural electrification and energy access around the world.

Thesis Supervisor: Jose Ignacio Pérez-Arriaga
Title: Visiting Professor, Sloan School of Management
Professor, Electrical Engineering, Comillas University

Thesis Supervisor: Claudio Vergara
Title: Postdoctoral Associate, MIT Energy Initiative

Acknowledgments

The scale of the effort needed to universally deliver energy access solutions, which requires coordinated technical-, economic-, and policy-focused work, is massive. But being involved in a project which addresses this monumental challenge has been incredibly exciting, especially because I've had the opportunity to be a part of the endeavor delivering life-changing solutions and promoting low-carbon power development for the world. I have been able to learn from a number of great people and I've been supported by my close friends throughout this journey at MIT which has taken me to areas around the globe.

First and foremost, I am grateful to Professor Ignacio Pérez-Arriaga for accepting me into the Universal Access Lab. I have learned so much about technical and regulatory aspects of the electric power sector, both in the developing and developed country context, from you. It has been a pleasure to be a part of your team.

Dr. Robert Stoner, I have enjoyed learning from your clear and insightful style of interaction. I also appreciate the opportunity, which you and the Tata Center have allowed me, to travel to India on multiple occasions to gain an understanding of the energy landscape from the Indian context. And to the core team which makes the Tata Center work--Gail, Jazy, Chintan, and Ben--thank you for your dedicated support.

Claudio, you are very intelligent and curious and it has been exciting for me to follow your sense of adventure. I appreciate the time that you have spent with me exploring new techniques and concepts.

Stephen and Cailinn, what a journey it's been together! Having you two beside me in classes, research discussions, and abroad has been invaluable and so incredibly enjoyable. To my newer and remarkably capable teammates--Roxanne, Matt, and Olamide--best of luck continuing to develop this project and learn so much about the world. And to the final and equally valuable core members of the MIT-side of the team--Reja, Vivian, and Yael--I have enjoyed working closely with each of you.

To the Comillas-side of the team--Fernando, Andres, and Pedro--thank you for constantly and patiently putting up with the difficulties of developing solutions from across an ocean. Your attention to the success of REM is impressive. And Carlos Mateo, thank you for your diligent development of RNM and for fielding my constant questions.

The Technology and Policy Program has been an exceptionally developmental experience in my life which has taught me how to examine any issue from multiple angles. Frank, Barb, and Ed--thank you for your valuable service leading such an important program. One of the most significant features of the program has been the interactions I have had with my fellow classmates: Thank you to my friends in the Classes of 2015 and 2016 for your guidance, my fellow Class of 2017 for your companionship, and the future Class of 2018 for your inspiring

ambition and enthusiasm to create solutions for a world which desperately needs them.

The MIT Energy Initiative has been my home for my two years of academic exploration. Thank you to every member of the community which has supported me, created a friendly and collaborative environment, and oftentimes literally fed a hungry graduate student!

To the partners of my research team, thank you for providing data and for your constant attention to delivering high-quality results. To the Tata Power DDL team--Praveer Sinha, Ganesh Das, Sugata Mukherjee, Tarun Batra, and Sumeet Kakru--I have enjoyed visiting your India and collaborating on the development of microgrids to make a difference in countless lives. And to the Uganda-GIZ team--Ashley Wearne, Martin Kretschmer, Ketty Adoch, and Diego Lopez--I am excited to see what electrification solutions will be possible for Uganda!

And last, but absolutely not least, a special thank you is due to my family which has supported me since Day One. Thank you for your support in all of its forms as I've expanded my limits in the MIT environment. And Meghan, you are a rock, in the most deep and sincere way possible. You have been my constant source of encouragement.

Contents

1	Introduction	15
1.1	Background and Motivation	15
1.2	Research Questions	19
1.3	Context of the Work	20
1.4	Preview	21
2	The (Regional) Reference Electrification Model and a Case Study in Rwanda	23
2.1	Overview Description of REM	23
2.2	Literature Review of Existing Network Planning Tools	25
2.3	Architecture of Regional REM	27
2.3.1	Inputs	27
2.3.2	Solution Method	28
2.3.3	Outputs	31
2.4	Final Model-related Considerations	32
2.5	Case Study of the Kayonza Region of Rwanda	33
3	The (Local) Reference Electrification Model and a Case Study in India	39
3.1	Overview Description of LREM	39
3.2	Literature Review of Global Microgrid Situation and Existing Microgrid Design Tools	40
3.3	Architecture of LREM	43

3.3.1	Inputs	43
3.3.2	Solution Method	44
3.3.3	Outputs	45
3.4	Case Study of Bahlolpur Village in India	46
4	Estimating the Electrification Status of Buildings and a Case Study in Uganda	55
4.1	Overview Description of the Estimating Electrification Status of Buildings	55
4.2	Literature Review on Estimating the Electrification Status of Buildings	58
4.3	Approaches to Estimating the Electrification Status of Buildings	59
4.3.1	First Approach: Circles around Distribution Transformers	60
4.3.2	Second Approach: Artificial Low Voltage Networks	61
4.3.3	Third Approach: Score-based Estimation	62
4.3.4	Next Steps Forward	64
4.4	Case Study of the SST in Uganda	65
4.4.1	Score-based Estimation Applied to this Case Study	66
4.4.2	Gaussian Processes Applied to this Case Study	68
5	Calculating Upstream Network Reinforcements and a Case Study in Rwanda	69
5.1	Overview Description of Upstream Network Reinforcements	69
5.2	Literature Review of Network Reinforcement Concepts	70
5.3	Description of Theory	72
5.3.1	Absolute and Relative Costs of Energy	72
5.3.2	Current Representation of Network Reinforcements within REM	72
5.4	Description of the UNR Process	73
5.5	Cost Allocation Methods	75
5.5.1	Allocating the Cost of Upstream Network Reinforcements on a \$/kW Basis	75

5.5.2	Method 1: Run Brownfield RNM Simultaneously for All GE Clusters	77
5.5.3	Method 2: Run Brownfield RNM for One GE Cluster at a Time . . .	78
5.5.4	Method 3: Combination of Methods 1 and 2	80
5.6	Case Study of the Kayonza Region of Rwanda using Cost Allocation Method 1	81
5.7	Conclusions and Implications	88
6	Discussion and Conclusions	91
6.1	Utility of REM to its Stakeholders	92
6.1.1	Sensitivity Analysis	92
6.1.2	Grid Compatibility Standard for Microgrids	95
6.2	Future Work on REM	96
6.3	Final Thoughts	97
6.3.1	Solar Home Kits	97
6.3.2	Leapfrogging and Climate Change	98
A	Regional REM Input File Descriptions	105
A.1	Equipment Catalog	105
A.2	Local Information	109
A.3	User Options	112
B	Regional REM Output File Descriptions	115
B.1	Results Summary for Entire Case	115
B.2	Microgrid Cash Flow	116
B.3	Grid Extension Cash Flow	116
B.4	Isolated System Cash Flow	117
B.5	Microgrid Dispatch	117
B.6	Network Files	118

List of Figures

1-1	Sources of energy access deficit	17
2-1	Structure of REM workflow	29
2-2	REM clustering process	30
2-3	Google Earth view of the Kayonza region in Rwanda	33
2-4	Existing MV distribution network in Kayonza	34
2-5	Electrified and unelectrified buildings in Kayonza	35
2-6	Load profiles of each building type in Kayonza	36
2-7	Examples of individual cluster projects developed by REM for Kayonza . . .	37
2-8	Minimum cost electrification solutions produced by REM for Kayonza	38
3-1	Structure of LREM workflow	44
3-2	Launch event of the Tayabpur microgrid, January 2017	47
3-3	Google Earth view of Bahlolpur village in the middle of the Ganges River . .	48
3-4	Satellite imagery-derived building locations in the vicinity of Bahlolpur . . .	48
3-5	Bahlolpur microgrid design for demand x1 (A, B, & C)	51
3-6	Bahlolpur microgrid design for demand x4 (A), x2 (B), x2 (C)	52
3-7	Bahlolpur microgrid design for demand x14 (A), x7 (B), x7 (C)	53
4-1	Range of average annual household energy consumption across countries with various degrees of energy access	57
4-2	First approach to estimating the electrification status of buildings	60

4-3	Second approach to estimating the electrification status of buildings	61
4-4	Second approach to estimating the electrification status of buildings applied to the Vaishali region of India	62
4-5	Google Earth view of the South Service Territory (SST) in Uganda	65
4-6	All buildings (386,000) in the SST of Uganda	66
4-7	DMSP-OLS nighttime lights layer superimposed over SST of Uganda	67
4-8	Third approach to estimating the electrification status of buildings applied to SST of Uganda	67
4-9	Gaussian processes applied to SST of Uganda	68
5-1	Upstream network reinforcements process	73
5-2	Daily load profile of two different clusters of consumers	76
5-3	Cost Allocation Method 1	77
5-4	Cost Allocation Method 2	79
5-5	Example network for Cost Allocation Method 2	80
5-6	Available input data for Kayonza	81
5-7	Greenfield network layout generated by Greenfield RNM	82
5-8	Breakdown of residential electricity bills in different jurisdictions in 2014-2015	84
5-9	Minimum cost electrification strategy produced by REM for Kayonza	85
5-10	Brownfield network layout generated by Brownfield RNM	86
5-11	Updated minimum cost electrification strategy produced by REM for Kayonza	88
6-1	Sensitivity case examples produced by REM of the Vaishali region of India	94
6-2	Estimated cumulative sales of small-scale lighting products in Sub-Saharan Africa	98
6-3	Cost trends of solar home systems in Sub-Saharan Africa	98

List of Tables

1.1	Current and projected populations without access to electricity	16
2.1	Distribution of electrified buildings in Kayonza	35
2.2	Parameters and assumptions used in REM for the Kayonza case	36
4.1	World Bank multi-tier matrix for measuring access to household electricity supply	56
5.1	Greenfield network specifications generated by Greenfield RNM	83
5.2	Transformer and substation specifications generated by Greenfield RNM	83
5.3	Example network topology produced by Greenfield RNM	84
5.4	Brownfield network specifications generated by Brownfield RNM	86
5.5	Transformer and substation specifications generated by Brownfield RNM	86
5.6	Summary of REM case studies in Kayonza	89

Chapter 1

Introduction

This thesis adds to the existing work in the area of computer-assisted tools and models used to support rural electrification planning efforts. Specifically, this document will provide a description and relevant case examples of the Reference Electrification Model, investigate the challenges associated with determining the electrification status of buildings, and address the network-related implications of connecting new loads to the existing electrical grid.

1.1 Background and Motivation

Energy is one of the most significant drivers of our modern economy--it facilitates the operation of virtually all sectors of our society--in addition to enabling human development. The developed countries of the world are grappling with reconceptualizing energy generation and consumption to mitigate climate change impacts and national security concerns. The developing countries must consider these same issues, while also simultaneously deciding energy infrastructure investments and addressing energy accessibility for their citizens. The leading national policies of the developing countries will strike the optimal balance between progressive economic development, attentive environmental protection, and efficient management and delivery of energy services.

Despite the significant digital and technical advances in the electric power sector within the last few decades, expanding universal access to energy¹ remains a pressing and largely unsolved issue in the developing countries of the world. The scale of this problem is often cited as justification for researching energy access, but the statistic must be repeated

¹In the context of this thesis, the term “universal energy access” shall refer primarily to access to electricity. Though other forms of energy, such as heat energy, are necessary to provide comfort and improve living conditions for individuals, my research is focused on the development of electrical networks and the provision of electrical energy (i.e. electricity). Other non-electrical energy access efforts, though also important, may be focused on aspects like cooking services, mobility, and mechanical operations.

here because of its staggering enormity and for the fact that it has hardly changed in the last few decades: The International Energy Agency (IEA) estimates that there are 1.2 billion people--approximately 16% of the global population--who lack access to electricity, and many additional people suffer from a poor quality of service. On top of this electricity access deficit, 2.7 billion people lack clean cooking facilities, a deficiency which contributes significantly to health issues but cannot easily be resolved by low-levels of electricity service [1]. Additionally, the universal energy access challenge is not likely to be rapidly resolved: In the IEA's New Policies Scenario, more than 780 million people are projected to remain without access to electricity in 2030 and 540 million still in 2040 [2].

The majority of these people without electricity or with poor service live in rural areas--primarily in sub-Saharan Africa and the developing parts of Asia--where it is typically more expensive and difficult to provide connections to the existing electrical network; institutions and companies have not been able to cope with the access problem adequately in these areas. Table 1.1 displays the IEA's data on the current distribution of populations across the world without access to electricity, and the table also projects how these numbers will change in the future decades based on the New Policies Scenario. Figure 1-1 provides an aggregated visualization of these statistics, and it further exemplifies the disparity in rural versus urban connectivity rates. How can policies and technologies be designed and partnerships managed in order to accelerate universal energy access to billions of people, while respecting the regional dimensions of social, political, economic, and technical constraints at work within this prodigious challenge?

	Populations (million people)		
	2014	2030	2040
Africa	634	619	489
Developing Asia	512	166	47
Latin America	22	0	0
Middle East	18	0	0
World	1,186	784	536

Table 1.1: Current and projected populations without access to electricity in the IEA's New Policies Scenario. Adapted from [2].

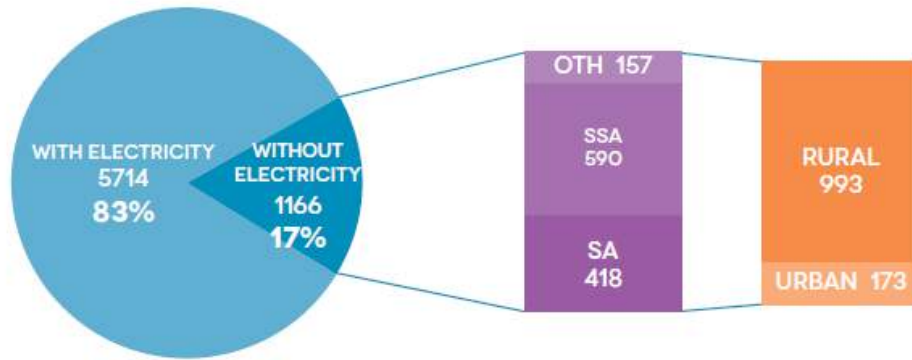

Figure 1-1: Source of electrification access deficit, 2010. Reprinted from [3].

There is an ever-growing body of literature which emphasizes that access to affordable and reliable electricity service is critical to enabling human development. Electricity has a strong correlation with poverty alleviation through increased income and economic status, improved health, support of educational opportunities, empowerment of women, and mitigation of environmental harm. The following short sample of evidence from the existing energy access literature supports the beneficial principal of electricity access in human development scenarios:

- Ahmad, Mathai, and Govindan conducted a 2013 survey of electricity access in rural Indian households and noted a significant positive relationship with school enrollment and an inverse correlation with absenteeism and early death [4].
- Chakravorty, Pelli, and Marchand led a survey of rural Indian households from 1994-2005 and concluded that non-agricultural income increased by 9% during the period of the study when the household received grid connection, and it increased by 29% when the household was provided with higher quality electricity [5].
- Kanagawa and Nakata calculated, based on data collected in the Indian state of Assam, that a 1 point increase in the electrification rate translates to a 0.17 point improvement in the literacy rate, but also that energy access has ripple effects on other factors (e.g. gender equality, environment). Furthermore, using data from the IEA, these authors demonstrated a strong correlation between electricity consumption and the Gross Domestic Product and Human Development Index, which is composed of data on life expectancy, education, per capita GDP, and other national standard-of-living indicators, in 120 countries [6].
- Goldemberg, Johansson, Reddy, and Williams examined the correlation between per capita energy use and the Physical Quality of Life Index, which considers infant mortality rate, life expectancy, and literacy. When compared for a large number of countries,

per capita energy use rates of 1 to 1.2 kW resulted in the most significant PQLI gains, while there were diminishing returns for energy consumption after this point [7].

Ensuring universal access to affordable electricity is a growing global priority which requires financial, technical, and policy support. The United Nations has identified energy access as Goal #7 of its Sustainable Development Goals (“ensure universal access to affordable, reliable and modern energy services”) necessary to end poverty, protect the planet, and ensure prosperity for all [8]. Committed initiatives like Sustainable Energy for All (SE4ALL), Power Africa, Energy + Partnership, and Lighting Global are working to deliver solutions to the energy access dilemma. Development banks, countries (both developed and developing), microgrid entrepreneurs, traditional electric utilities, and many other entities are examining strategies by which the existing electric power grid can be improved and new connections can be provided to consumers without access to energy services.

The model of the traditional electric power grid, in which generation occurs at some central location and is transmitted through transmission and distribution networks to the end consumers, has a role to play in this energy access challenge if new distribution lines can be extended to previously unserved areas. However, this model is slow and the need for energy access is immediate. Newer concepts in the power sector, like distributed energy resources (DERs) or microgrids (which should be designed to be grid-compatible in those areas that can eventually be reached by a grid extension), will make a significant contribution to this energy puzzle. Additionally, lower-cost solutions, such as home solar kits, are more affordable and accessible for many of the world’s poor consumers without access to energy. Due to the scale of the energy access problem, the right electrification answer will likely not be one single option, but rather, all possible approaches should be explored and utilized in a coordinated manner in order to deliver electricity to all consumers around the globe. Additionally, partnerships, cooperations, and discussions between public and private actors at all levels (i.e. local, state, national, and global) can serve to expedite solving the challenge of universal energy access and provide robust solutions.

Electrification strategies should be aware of external considerations and take care to be comprehensive in their planning criteria. For example, global emissions levels are at an all-time high, and providing energy access to more than a billion new consumers could worsen the situation. Adoption by the developing nations of the traditional model of the electric power system used by industrialized nations could present a threat to climate stabilization, particularly if centralized generation remains primarily dependent upon fossil fuels instead of renewable energy technologies. Newly connected consumers could continue the traditional reliance on fossil fuel generation at the centralized level, but they also have the opportunity to leapfrog past traditional, polluting technologies and instead utilize cleaner energy resources. Additionally, microgrids, extensions of the existing grid, and standalone systems should complement one another in master electrification plans. If an extension of the central grid were to arrive to an area which makes use of an alternative electrification technology (e.g. a

microgrid), the grid should allow for the interconnection of this alternate system, rather than rendering it obsolete and constructing a parallel set of wires running to the same houses.

Solving the rural electrification challenge will require a multi-stakeholder approach to address numerous technical, political, economic, environmental, and social challenges in diverse areas around the world. Decision support tools (e.g. models) can serve to provide additional guidance and insight in order to complement existing methods in this multi-faceted challenge. It was in response to the need for a comprehensive tool which could provide rural network planners with additional information that development of the Reference Electrification Model (REM) started several years ago. REM uses the geographic location of consumer positions and any existing electrical distribution network in combination with information on consumer affordability, grid reliability, weather patterns, and numerous other factors to design the least-cost electrification system for all of the consumers in a region.² REM can be used to assist microgrid entrepreneurs, distribution companies (DISCOMs), regulators, electric utilities, and many other stakeholders which would be interested in planning optimal electrification system designs and projecting their associated costs. The architecture and some potential applications of REM have been described by previous students of the Universal Access Lab [9],[10],[11],[12], [13].³ This thesis seeks to continue the development of REM while exploring new applications of the tool within the context of rural electricity access.

1.2 Research Questions

The Universal Access Lab has developed state-of-the-art computational methods to design optimal electrification solutions in rural and developing areas of the world. These methods make a series of assumptions and simplifications in order to handle many of the uncertainties and complexities associated with rural electrification planning. In this thesis, I will contribute to improving several of the methods associated with the computer-assisted electrification design process.

The central theme which I will address in this thesis is: *How can a computer decision support tool be developed and used to plan electrical network designs in rural and developing areas around the world in order to provide universal energy access?*

This overall theme will be answered through four separate questions applied to different rural electrification challenges, which are each presented below:

²A full description of REM and its potential uses will be provided in Chapters 2 and 3.

³The Universal Access Lab is led by Professor Ignacio Pérez-Arriaga and is jointly located at MIT and IIT-Comillas University (Madrid, Spain). For more information on the motivation and findings of this group, please visit <http://universalaccess.mit.edu>.

1. How can the standard, or regional, version of REM be used to design networks and decide between optimal electrification systems in real implementation cases?
2. How can the localized version of REM, the Local Reference Electrification Model (LREM), be used to size generation assets and design networks for collections of buildings in a community?
3. How can the electrification status of buildings be estimated under uncertainty and lack of accurate data?
4. What are the upstream network reinforcement costs and implications associated with providing new connections to the existing grid to significant electrical loads?

Ultimately this thesis will contribute to the improvement of computational electrification planning techniques so that more effective electrification strategies can be developed for rural consumers in developing countries. By utilizing REM as a computational reference tool, rural electrification planners around the world will be able to more accurately provide electricity service for their populations and understand the technical, financial, and socioeconomic implications of their actions. Additionally, the results of this work can be discussed with policymakers in countries with low electrification rates so that the critical task of expanding energy access can be better understood and approached.

1.3 Context of the Work

I have particularly enjoyed working on the research presented in this thesis because it has been applied to actual situations across the world. In both data acquisition and development stages of this work, I have traveled to multiple countries and interacted with representatives of various government agencies, private companies, and NGOs. A significant focus of this research has been on India, a country where the scale of the energy access problem is enormous, because of the generous funding support of the MIT Tata Center for Technology and Design.⁴

I have had the privilege of travelling to India on four separate occasions during the course of my research on this project in order to gather data, meet stakeholders, and adapt REM to the needs of partner organizations in the country. Therefore, many of the findings, insights, and results of my research come from India's situation and the interactions I have had with this country. However, the challenge of energy access is certainly not confined to

⁴The MIT Tata Center, which supports innovation and entrepreneurship to address the challenges of communities in the developing world, was founded in 2012 with generous support from the Tata Trusts, one of India's oldest philanthropic organizations. The Trusts have been working to empower the under-served communities of Indian society since 1919. For more information, see <https://tatacenter.mit.edu>.

India, and my team and I have interacted with many other countries (e.g. Uganda, Rwanda, Colombia, Kenya, Nigeria) to make use of our model in order to improve planning situations in these areas. The results of this research are grounded in real energy situations and aim to improve the conditions of areas where we have worked.

1.4 Preview

The rest of this document will be used to address the questions presented in Section 1.2. In Chapter 2, I will provide a description of the architecture of REM and apply the tool to a region in Rwanda. In Chapter 3, I will describe LREM and use the tool to build an off-grid energy system for the village of Bahlolpur in Bihar, India. Chapter 4 is devoted to the challenge of estimating the electrification status of buildings and will be focused on a territory in Uganda. In Chapter 5, I will explain a process to calculate the cost of upstream network reinforcements and demonstrate an example in Rwanda. Chapters 2 - 5 will have their own respective literature reviews at the start of each chapter, rather than providing one comprehensive literature review for the entire thesis. And finally, in Chapter 6 I will deliver my conclusions and final thoughts about universal energy access and rural electrification.

Chapter 2

The (Regional) Reference Electrification Model and a Case Study in Rwanda

2.1 Overview Description of REM

To inform prudent decisions about the best means to address energy access in a region, the Reference Electrification Model computes the minimum cost strategy to provide a desired level of electricity service to a population characterized in terms of its spatial distribution and estimated potential demand for electricity, both down to the individual building level. Numerous factors influence the choice and configuration of a particular electrification system design: Providing energy access in developing countries is often complicated by limited funding support, rudimentary planning methods, significant uncertainty about the current and future demand to supply, a multitude of distributed consumers without access to energy, and the decision between using a diverse set of electrification strategies. By computing detailed technical designs and hourly simulations of multiple electrification strategies, the model is able to perform a quantitative comparison between extending the existing electrical grid, constructing standalone microgrids, and providing independent electricity sources for each building. REM offers planners the ability to calculate and visualize optimal¹ electrification strategies which satisfy their technical, financial, and economic constraints.

REM uses input data on the supply costs of the existing grid, anticipated consumer demand, available generation and network equipment, local weather conditions, and many other technical factors to produce hourly simulations, detailed costs, and system designs necessary to provide each identified consumer with electricity service. For each individual building defined in the input dataset, REM will ultimately select one of three electrification technologies appropriate for their specific situation:

¹Optimization in the context of this model refers to providing the minimum cost electricity supply.

1. **Grid Extension (GE):** Extension of the existing grid, which utilizes large-scale centralized energy generation, transmission, and distribution services to serve anywhere from thousands to millions of consumers.
2. **Microgrid (MG):** Localized, small- to medium-sized power systems which provide electricity via a local distribution grid to several domestic, business, and institutional consumers within the same area. The average number of consumers connected to a microgrid depends on national preference as well as technical and geographic constraints. Typically these systems will utilize a combination of solar photovoltaic panels, battery storage backup, and a diesel generator, although there are other technology possibilities as well.
3. **Standalone System (SA):** An isolated off-grid energy system which exclusively serves a single domestic, business, or institutional consumer. A domestic consumer may use a solar PV-based home lighting system, while a larger consumer may rely on a diesel generator for their more significant energy demand.

REM has two modes of utilization: 1) **Regional REM**, in which an electrification strategy is planned for an entire country or some large region, and 2) **Local REM**, in which an off-grid system (i.e. microgrid) is designed for a single village or a collection of buildings. These two modes are utilized independently: For a group of buildings, Regional REM will design optimal generation assets and network designs for a grid extension, microgrid, or standalone system. Local REM precisely designs the optimal portfolio of microgrid components and the network layout for the selected buildings. These two versions of REM rely on most of the same algorithms for their respective operations, but they have independent interfaces. Regional REM will be described in this chapter and Local REM in the next chapter.

To plan these systems and advance rural electrification efforts, REM uses a combination of mathematical optimization algorithms and heuristics which seek to minimize total overall costs. For example, REM will recommend that a set of consumers should be connected to a microgrid if constructing a microgrid for the defined consumers under a set of conditions would be less costly than connecting the consumers to a grid extension project. REM considers the costs of a system to include generation, network, and other technical costs, as well as the Cost of Non-served Energy (CNSE), in its cost minimization criteria. This metric, the CNSE, represents the cost or inconvenience incurred by a consumer when electricity service is not available when it is desired. REM classifies each system load as either critical or non-critical; the model requires a separate CNSE value for the critical and non-critical load classification in order to place a higher priority on ensuring the delivery of supply to the critical loads of the system. The CNSE is also needed to produce the optimal generation and network designs which balance cost of supply and quality of service. For a greater discussion of CNSE and its implementation within REM, refer to [10] and [12].

REM uses a greenfield version of the Reference Network Model (RNM) to produce precise network designs and costs. RNM was developed by the Instituto de Investigación Tecnológica of Universidad Pontificia Comillas in Madrid as a large-scale distribution planning tool to help regulators estimate efficient costs in distribution incentive regulation [14]. RNM can be used to plan distribution networks from scratch (i.e. greenfield planning) or incrementally from an existing grid (i.e. brownfield planning); the two versions of this model will be discussed further in Chapter 5.

2.2 Literature Review of Existing Network Planning Tools

In many utilities and network planning organizations around the world, rural electrification planning is oftentimes performed by hand and with “rule of thumb” guidelines. The planners in these groups are knowledgeable about their local territory and make use of tried-and-true methods in order to design new additions to their network. These conventional approaches commonly produce reasonable results.

However, the landscape surrounding network planning is shifting as universal energy access becomes a global priority. Planning energy systems for universal energy access now presents an enormous task due to the sheer size of this activity in which billions of consumers require reliable electricity service. Information on consumer locations and their anticipated electrical demand may be unknown. Off-grid technologies (e.g. microgrids), which are expected to play a significant role in the future of rural electrification, must be considered alongside traditional methods of extending the existing electrical grid in planning decisions. Network planning methods must keep pace with rural electrification progress.

New computer-based approaches which utilize GIS spatial analysis and advanced computational and optimization techniques offer the potential to increase efficiency and accuracy in the area of electrical network planning. In addition, high-quality satellite imagery can be combined with image recognition techniques to locate buildings or other notable features in order to produce correct and realistic designs. Many of the newly developed software solutions are intended to be accessible by planners around the world, particularly by those who are on the ground in areas with a high need for energy access solutions.

I have surveyed other decision support tools from the existing literature which are intended to address rural electrification challenges. The tools which I have researched are described below in terms of their advantages and disadvantages with respect to REM’s characteristics:

Network Planner Developed by the Modi Research Group at Columbia University, Network Planner² meets many of the same rural electrification planning needs as REM and is likely the most similar product currently on the market. Network Planner is described on its website as “An online tool for planning Grid, Mini-grid and Off-grid electricity from community to national scale.” This tool has a functioning web interface which allows users to input their case-specific data, then the tool optimizes possible electrification options for rural communities. Network Planner has been applied in a case example in Nigeria to highlight its features [15]. Network Planner uses optimization algorithms and GIS capabilities to produce optimal and cost-effective electrification designs. However, Network Planner’s electrification planning techniques are less rigorous than those employed by REM because the tool considers its inputs on an aggregated community level (e.g. at the local government area level in Nigeria), while REM is able to handle building-level analysis. Additionally, the produced engineering designs for both on-grid and off-grid systems are not rigorous in the sense that they do not provide a component-level breakdown of generation and network requirements.

LAPER The Rural Electrification Planning Software (LAPER) was developed jointly by Electricité de France (EDF) and the French Agency for Environment and Energy Management (ADEME). This tool seems to perform many of the same electrification optimization techniques as REM, but it is actually able to consider additional generation resources like hydro- and wind power in its final designs. It seems that LAPER aggregates electrification results at the village level, but the tool’s exact results are difficult to discern because there is a lack of comprehensive literature on this tool and the latest available publications are only as recent as the early 2000’s [16].

Energydata.info The World Bank has provided *Energydata.info*, a platform which hosts a collection of open-access apps relevant to the energy sector, to the public on its own website in order to “share data and analytics that can help achieve the United Nations’ Sustainable Development Goal 7 of ensuring access to affordable, reliable, sustainable and modern energy for all.” Many of the platform’s apps provide functions which resemble some of the components of REM.

- *Off-Grid Market Opportunities* can be used to estimate market opportunities for off-grid energy services in Sub-Saharan Africa by calculating the number of households and estimated revenue in a defined area which meet selected conditions. This particular tool is useful for estimating the potential number of households which could be connected to an energy system, but it lacks the granularity and rigor required to produce results which could be highly useful by network planners.

²Network Planner is available online at <http://networkplanner.modilabs.org>.

- *Global Solar Atlas* provides a calculation of the potential solar energy which could be generated for any area in the world.
- *Electrification Paths* seems to be the app most similar to the full suite of REM’s functionalities. Users of this app can select a country (the app is currently limited only to countries in Africa and the Americas) and then choose from among a few preset grid electricity prices, diesel prices, and demand levels. The app comes pre-loaded with network information for its available countries and, depending on the input configurations selected, will estimate the minimum cost mix of technologies which could provide full electricity access for the country’s population. This app could be useful for quickly obtaining a snapshot of a possible path to universal energy access, but it lacks the sophistication to take into account complete network configurations, exact building locations, and advanced user setting preferences.
- *Regulatory Indicators for Sustainable Energy (RISE)* rates countries on their policies and regulations in the energy sector on the basis of three pillars: Energy Access, Energy Efficiency, and Renewable Energy. For each country, this tool provides a page which compiles the current regulations and policies as they relate to the three previously mentioned areas. RISE could be helpful in locating regulation and policies to judge the effectiveness of electrification plans and attract investment.
- *India Night Lights* aggregates over 20 years’ worth of available nighttime lights data for India. This tool could potentially be used to judge the effectiveness of various electrification schemes, provided that the results of the schemes could be observed by satellites (e.g. construction of streetlamps in villages). The usage of the DMSP-OLS nighttime lights dataset within the the context of my research will be discussed in Chapter 4.

2.3 Architecture of Regional REM

2.3.1 Inputs

Regional REM requires a series of input data, which are briefly described below, to process a case.³ For a more comprehensive description of the individual components which make up each input file, refer to *Appendix A*.

The input files necessary to run the model are organized into the following categories, and the files composing each category are numbered below each category heading:

³It should be noted that data preparation (i.e. data gathering, cleaning, and pre-processing) can be one of the most difficult and time-consuming steps associated with running a case with REM.

- **Equipment catalog:** Specifies the technical and economic information of all generation and network components and systems available in the region of study.
 1. Distribution lines (includes information on poles, insulators, and conductors)
 2. Transformers (corresponding to three-phase equivalent values)
 3. AC/DC converters
 4. Charge controllers
 5. Internal combustion engine (ICE) generator
 6. Photovoltaic (PV) generators
 7. Batteries
- **Local information:** Includes details specific to the region of study.
 1. Buildings⁴
 2. Existing distribution network
 3. Solar resource
 4. Load profiles
 5. Load profiles decomposition
 6. Generation look-up table coordinates
 7. Terrain elevation
 8. Penalized areas
 9. Village boundaries
- **User options:** Contains parameters which are specific to the case and reflect the preferences of the user of the model. Some of the inputs in this category will affect the operation of the model's algorithms.

2.3.2 Solution Method

The structure of the model has evolved over several iterations since the development of REM first began; the architecture of REM as described in this section differs slightly from the architecture of REM described in previous theses by members of the Universal Access Lab [9],[10],[11],[12],[13].

⁴If the location and/or electrification status of each building in the region is not known, it is possible to use building extraction techniques using satellite imagery developed by the Universal Access Lab to collect this information. Refer to Stephen Lee's thesis (to be published) for additional insight on this subject.

The general approach within the model to solve electrification planning for a region is through sequential Clustering, Design, and Comparison steps, where the Clustering step employs the *ogsupply*, *mgnetwork*, and *extendgrid* functions. Figure 2-1 displays the workflow of an execution of REM for a case, where the input and output files on both extremes of the diagram are described in detail *Appendix A and B*, respectively.

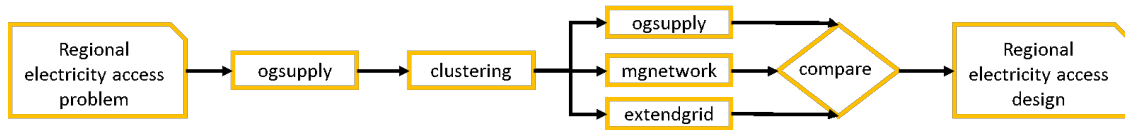

Figure 2-1: Structure of REM workflow

The general description of the workflow for a case is described in the list below, then additional details are provided for the Clustering, Design, and Comparison steps.

1. Obtain off-grid supply designs for a number of relevant combinations of user types
2. Clustering: Group buildings into grid-extension, off-grid microgrid, and off-grid standalone systems
3. Design:
 - (a) A grid-extension design for each grid-extension cluster;
 - (b) A distribution network design for each off-grid microgrid cluster;
 - (c) An off-grid electricity supply design for each off-grid microgrid cluster and for each customer type.
4. Comparison: Compare electrification modes on a cost basis

Clustering The process of clustering is used to identify the groupings of buildings which will eventually produce minimum cost grid extension or off-grid system designs. REM relies on a version of the Minimum Spanning Tree algorithm to inform the best connection possibilities between all of the buildings in the region. The search space for defining possible clustering combinations of all of the buildings can be unwieldy, particularly for a large region with many buildings. REM manages the complexity of all of the possible clustering options by minimizing reevaluation steps.

The model begins the clustering process by first building Proto-clusters, or groups of buildings which are located close to each other, are within the same village, or correspond to a combination of these two factors. Next, Proto-clusters may be grouped into larger Off-grid Clusters based on optimal cluster characteristics. Finally, Off-grid Clusters may be grouped into even larger On-grid Clusters, which could be attached to the grid via a grid extension project. Figure 2-2 provides a diagram which represents this process, where unelectrified buildings are contained within Proto-clusters, Off-grid Clusters, and then finally On-grid Clusters.

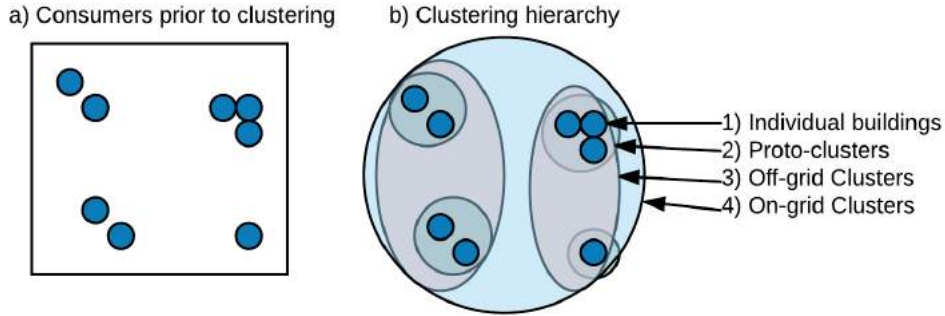

Figure 2-2: REM clustering process

Design This step produces a series of system designs and calculates their costs in order to inform the Comparison step.

1. For each On-grid Cluster identified in the above Clustering step, a grid extension is designed (*extendgrid*) to the nearest medium-voltage (MV) branch of the existing distribution network. The cost of this extension, which includes the network costs, non-served energy value, and the relevant cost of supply, is computed. The cost of upstream network reinforcements due to this On-grid Cluster interconnecting into the grid, a concept which will be discussed in Chapter 5, should be included within this total cost.
2. Each On-grid Cluster identified in the Clustering step may contain multiple Off-grid Clusters. For each Off-grid Cluster containing more than one consumer,
 - (a) A local energy supply system and distribution network (i.e. microgrid) is designed and its total cost is computed (*mgnetwork* and *ogsupply*).
 - (b) A standalone system is designed and its cost is computed for each individual building within the Off-grid Cluster (*ogsupply*).

Comparison All possible grid extension and off-grid designs are evaluated in this step in order to determine the final minimum cost system design.

1. For each Off-grid Cluster, the minimum cost decision between a microgrid or standalone systems for all of the buildings is selected in the Off-grid Cluster.
2. For each On-grid Cluster, the cost of a grid extension for the entire cluster is compared against the sum of all of the minimum cost off-grid options for the Off-grid Clusters within the On-grid Cluster; the ultimate minimum cost option is selected.

3. For every On-grid Cluster that was determined to be best served with off-grid systems, their respective Off-grid Clusters are reconsidered to possibly receive a grid extension.

2.3.3 Outputs

Based on the minimum cost design produced by the Clustering, Design, and Comparison steps, REM will specify that each building provided in the input dataset should receive a supply of electricity through one of three possible options:

1. **Grid Extension (GE)** project from the existing electrical network; this is the most common method employed worldwide to provide consumers with energy access.
2. **Microgrids (MG)** which provide electricity generation, storage, and distribution systems to a group of consumers away from the main grid. The microgrid designs which are produced by REM are alternating current (AC) based and use a set of solar PV panels, diesel generator, and battery storage, but in general microgrids can be built to be direct current (DC) based and can utilize other local resources (e.g. biodiesel plants, hydropower, wind power).
3. **Standalone Systems (SA)** provide electricity to only a single consumer or household. These systems can be either AC or DC based and may make use of water, biomass, solar, and diesel resources for generation; they can also be as elementary as a solar lantern.

In addition to simply determining which type of system each consumer should be connected to, REM produces a comprehensive series of output files for each case. A brief description of each output file is provided below, while a comprehensive list of the components which compose each output file is contained in *Appendix B*.

- **Results summary file** Contains a synopsis of all costs and connection decisions.
- For each **GE** project, the following information is produced:
 1. Cash flow
 2. Connected buildings
 3. Necessary distribution transformers
 4. Necessary LV lines
 5. Necessary MV lines
- For each **MG** project, the following information is produced:
 1. System dispatch

2. Cash flow
 3. Connected buildings
 4. Necessary distribution transformers
 5. Necessary LV lines
 6. Necessary MV lines
- For each **SA** project, the following information is produced:
 1. System dispatch
 2. Cash flow

2.4 Final Model-related Considerations

It is worth mentioning that the outputs from REM are not intended to be carved into stone and used unequivocally to plan out electrification decisions. As with all models, REM is dependent upon the quality of input data and assumptions provided. Often in the developing world, exact equipment cost figures, geographic locations of buildings, and other data are not precisely known. Therefore, to some degree, the outputs from REM will reflect the accuracy of certain input variables. Several case studies which my research team has applied REM to, like the Kayonza region of Rwanda, have produced highly accurate results because precise geo-located data was provided by a local agency. The results of other cases, such as the Vaishali region of India, took longer to produce because accurate and comprehensive data was not provided and assumptions in the face of uncertainty were developed.

REM is a static model, in that the system designs are specific to a single year, but the model takes year-to-year considerations into account in its final designs (e.g. discount rate, network lifetime, degradation of battery systems). One idea that is being considered by the research team is an iterative usage of the model (i.e. as more accurate data becomes available during the course of an analysis, REM can be re-run and the results of the case can be updated to reflect the new information).

REM should be used by stakeholders as a decision support tool which can help build scenarios and project costs, but the results of the model should be scrutinized before constructing a project using the designs produced by REM. For example, local agencies may know some technical or social details which would influence the overall system constraints which REM may not inherently take into account. REM can be executed multiple times to incorporate updated information and produce a more appropriate final design.

2.5 Case Study of the Kayonza Region of Rwanda

To demonstrate the model’s planning capabilities, REM is applied to a case study of Kayonza, a district in the Eastern Province of Rwanda. The region of Kayonza is highlighted in red within Rwanda’s borders in Figure 2-3. The results presented in this case study are not intended to demonstrate the definitive plan for electrification of Kayonza, since any final plan for an area would require multiple stakeholders to scrutinize the input data and assumptions, while instead these results are intended to showcase an overview of the model’s abilities. The data used in this case study were obtained from Rwanda’s Energy, Water and Sanitation Authority (EWSA).

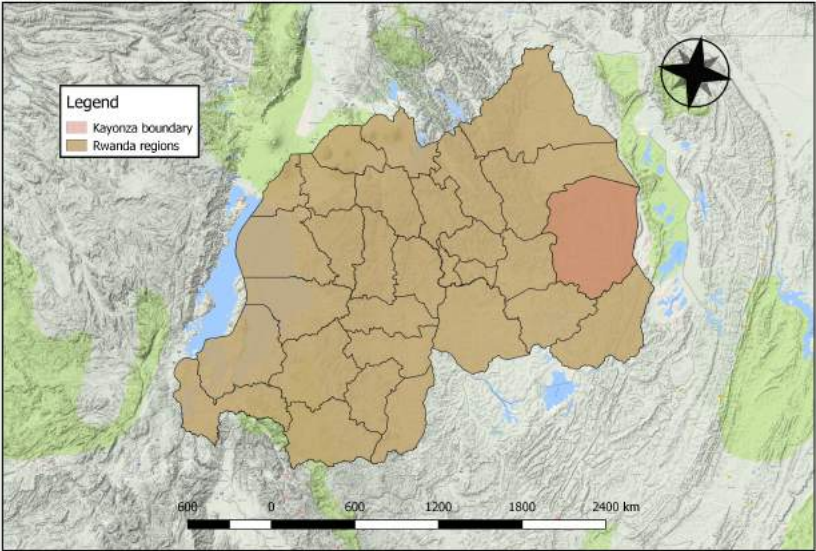

Figure 2-3: Google Earth view of the Kayonza region (red) in Rwanda

Network

The existing medium-voltage (11 kV) distribution network is displayed in black in Figure 2-4. This distribution network will be used as the initial structure to develop optimal electrification strategies for the buildings of the region.

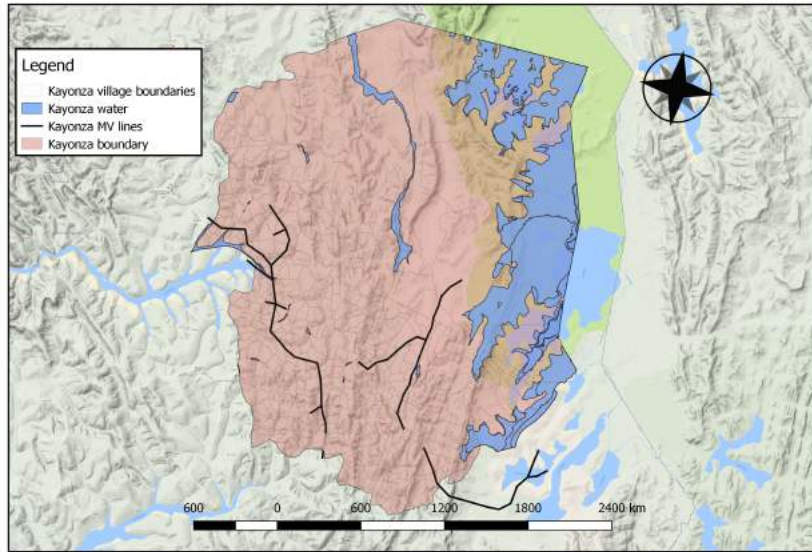

Figure 2-4: Existing MV distribution network in Kayonza

Buildings and Demand

The Kayonza case’s dataset includes the geographic coordinates of 49,593 buildings, although the electrification status labels for any of the buildings was not provided by EWSA. Several techniques to estimate building-level electrification status in the absence of accurate data will be discussed in Chapter 4. However, for simplification purposes, any building which is located within 500 meters of the distribution network is considered to be connected to the grid (i.e. electrified) in this case study. The value of 500 meters was selected because it roughly corresponds to the average length of a low-voltage line extended from a medium-voltage network interconnection point.

Using this electrification assumption, 8,777 of the buildings, or approximately 18% of all of the buildings in the dataset, are electrified; this percentage aligns with the official records for the region. Figure 2-5 illustrates the distribution of electrified (green) and un-electrified (red) buildings in the region, in which the unelectrified buildings are located along the length of the MV distribution network.

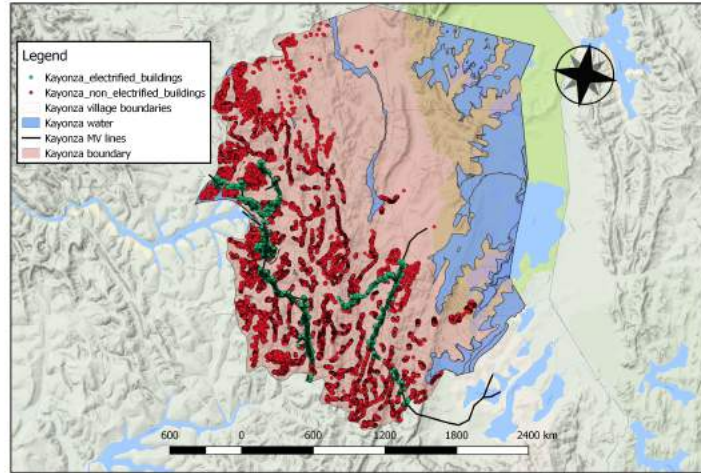

Figure 2-5: Electrified (green) and unelectrified (red) buildings in Kayonza

Each unelectrified building is categorized as one of ten different types of loads, where each load type has its own load profile (i.e. a defined pattern of energy consumption). The load profiles for each building type were built by aggregating representative survey data on appliance usage for each type of consumer; consumers specified which appliances they owned and during which hours of the day they used these appliances. REM developed each load profile by considering the survey data on appliance usage in addition to defined enabling criteria (e.g. fans switch on when ambient temperature exceeds some threshold value) and a variability metric which introduces stochasticity into the load profile dataset.

The distribution of load types for the unelectrified buildings of the dataset are shown in Table 2.1, while the respective load profiles of each of the load types are presented in Figure 2-6.

Type	Load Description	No. of Buildings
1	Large residential	7,992
2	Small residential	31,854
3	Primary school	29
4	Secondary school	22
5	Cooperative	58
6	Bank	41
7	Hospital	5
8	Government	8
9	Church	37
10	Shop	770

Table 2.1: Distribution of electrified buildings in Kayonza

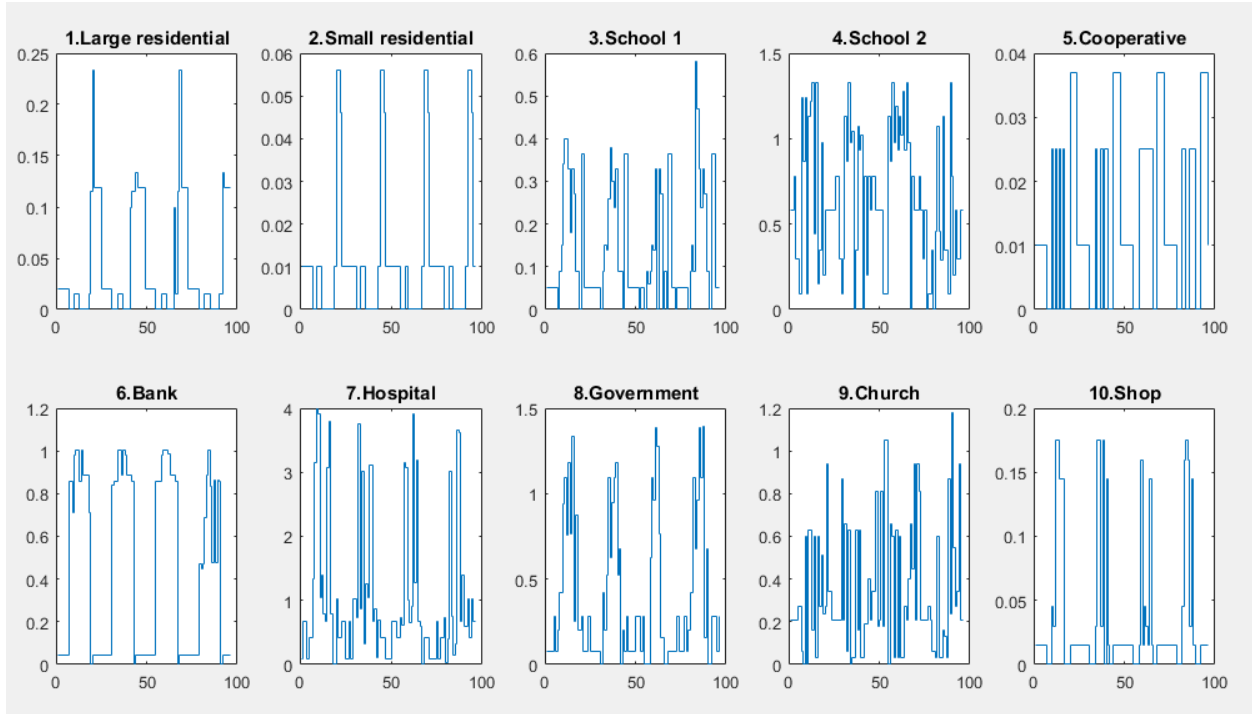

Figure 2-6: Load profiles of each building type in Kayonza

Input Parameters and Assumptions

A series of technical and financial parameters and assumptions were developed to run this case. A listing of several of the more important values with respect to the operation of the algorithms used in REM are listed in Table 2.2.

Parameter Name	Value	Units
Cost of Non-Served Energy (Non-critical loads)	0.75	\$/kWh
Cost of Non-Served Energy (Critical loads)	1.50	\$/kWh
Grid-energy cost	0.20	\$/kWh
Discount rate (GE)	0.08	p.u.
Discount rate (MG)	0.12	p.u.
Discount rate (SA)	0.20	p.u.
Diesel fuel cost	1.00	\$/L
Distribution system losses	0.05	p.u.
Network lifetime (GE)	20	years
Network lifetime (MG)	20	years
Demand growth rate	0.20	p.u.

Table 2.2: Parameters and assumptions used in REM for the Kayonza case

Results

To connect all of the unelectrified buildings in the dataset, REM developed 69 independent clusters: 39,609 buildings were connected to 64 grid extension clusters, 1,143 buildings were connected to 49 microgrid clusters, and 64 buildings were connected to their own standalone systems. The ultimate annuity of the entire electrification system was computed to be \$3,887,996.

An example of a grid extension project design connecting 1,705 buildings to the existing MV network is shown in Figure 2-7a, while an example of an independent microgrid project design connecting 135 buildings is shown in Figure 2-7b.

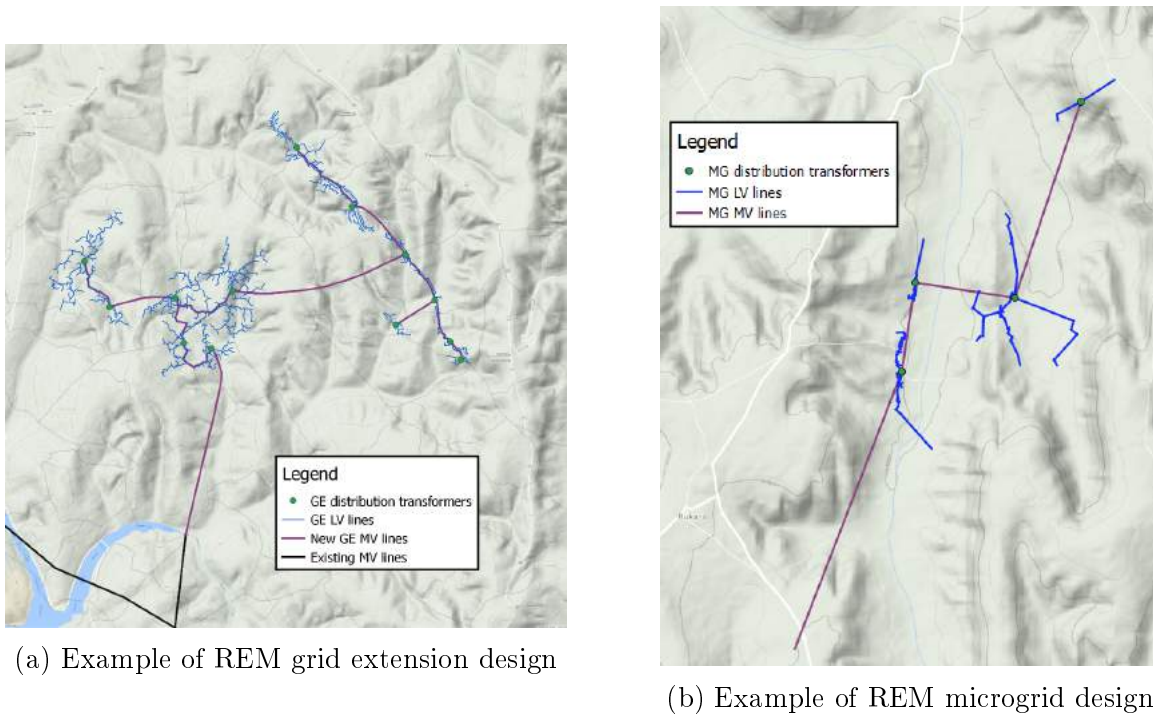

Figure 2-7: Examples of individual cluster projects developed by REM for Kayonza

And finally, an illustration of the final minimum cost electrification system designs applied to the entirety of the Kayonza region is provided in Figure 2-8. The shapes in black represent new grid extension projects, while the blue and green shapes represent new off-grid projects. The slider bar at the bottom of the figure represents the advantage that each off-grid project has in being either a microgrid or a standalone system instead of a grid extension. This off-grid advantage metric is calculated comparing the investment cost of a grid extension versus off-grid project design for the same set of buildings. The off-grid advantage formula is given below, where its output value will be positive if the minimum cost solution is an off-grid project:

$$\text{Off-grid mode advantage} = \frac{GE_{cost} - OG_{cost}}{GE_{cost}}$$

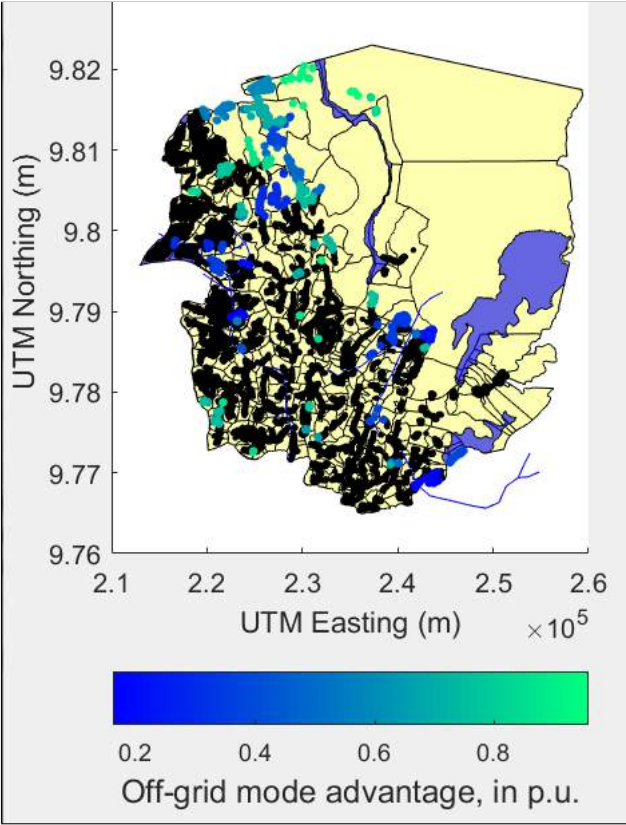

Figure 2-8: Minimum cost electrification solutions produced by REM for Kayonza

Chapter 3

The (Local) Reference Electrification Model and a Case Study in India

This chapter is intended to provide an overview description of the Local Reference Electrification Model’s capabilities and highlight one past application in which it has been utilized. This chapter is not intended to provide detailed descriptions on how to build the input files or run the model. Instead, refer to Vivian Li’s Master’s thesis [11] for a more exhaustive description of the development and architecture of this version of the model.

3.1 Overview Description of LREM

REM’s second mode of utilization is used to design off-grid energy systems (i.e. microgrids) for specified collections of buildings in order to improve local electrification planning. This mode of REM will be referred to hereafter as *Local REM*, or *LREM*. LREM shares functions with Regional REM, but it can be used as an independent tool to produce exact representations of off-grid generation and network designs. LREM is intended to assist developers and planners with optimal microgrid designs by producing exact technical and financial specifications. Additionally, LREM can compute the efficient cost of constructing a particular microgrid so that a regulator can receive a petition from a microgrid company and know what the efficient subsidy cost to provide should be.

When designing a detailed electrification plan for a large region, Regional REM must make a series of simplifying assumptions in order to assist with computation speeds, but LREM is able to provide exact calculations for the smaller area of interest. LREM does not utilize Regional REM’s clustering function nor does it pre-compute a generation look-up table, but instead it assumes that all buildings in the defined area should be connected to a single microgrid system. LREM then designs the network layout of the microgrid in order

to efficiently connect all consumers. It also calculates the capacity of necessary generation and storage assets needed to meet the consumers' anticipated demand profiles.

3.2 Literature Review of Global Microgrid Situation and Existing Microgrid Design Tools

Off-grid power has been often viewed as a “stop-gap” means to deliver electricity in remote areas of the world until the national grid is able to be extended. However, microgrids have already connected millions of global consumers to a supply of energy and proved that they can compete with the traditional electrification model of connecting consumers to the existing grid. Indeed, the global microgrid market was valued at \$9.8 billion in 2013, but it is projected to increase by an impressive 20.7% percentage to \$35.1 billion by 2020 [17]. This significant increase in the microgrid market can be partially attributed to the desire for an islanded mode operation of facilities for security purposes (e.g. at military bases). However, to a greater extent, microgrids are being built at a rapid pace in the developing countries, particularly in rural or remote areas, as a viable alternative technology to an extension of the existing grid.

Microgrids can provide a relatively affordable and reliable supply of electricity when political, economic, or geographic reasons preclude the grid from reaching a set of consumers. It is also common in some areas of the world for a microgrid to be built adjacent to the grid when the grid does not provide energy either at a dependable frequency or at voltage levels necessary to support common household appliances. The list below indicates several of the advantages of microgrids over the traditional electric grid within the global energy access challenge:

- Utilization of local resources (e.g. hydropower, wind power, biofuels)
- Reduced transmission and distribution losses due to smaller network size
- Easier to deploy, particularly in areas with low population density
- Grid compatibility interface to facilitate interaction with the grid
- Community participation with operation (e.g. billing collection, theft deterrence)
- Environmental benefits when renewable energy resources are exclusively used for generation
- Comparative ease of regulating voltage levels
- Minimal system curtailments (e.g. blackouts), so long as system demand respects technical constraints
- Adaptable and modular design, in the sense that more generation or storage assets can be added on later to meet increased demand, lines can be extended to connect new consumers, and the controller's dispatch logic can be reconfigured to meet new technical

constraints (e.g. minimize usage of a diesel generator for environmental reasons)

The U.S. Department of Energy Microgrid Exchange Group defines a microgrid¹ as

"a group of interconnected loads and distributed energy resources within clearly defined electrical boundaries that acts as a single controllable entity with respect to the grid. A microgrid can connect and disconnect from the grid to enable it to operate in both grid-connected or island-mode." [18]

This is a fairly broad definition which encompasses systems of varying levels of sophistication. For example, the company Mera Gao builds barebones-style microgrids in Uttar Pradesh, India which are intended to meet the basic needs (i.e. lighting and mobile phone charging) of the rural poor; Mera Gao's model must compete with the price of electricity's substitute, government-subsidized kerosene, which is difficult to do without a supportive regulatory framework. Alternatively, some of the more advanced microgrids currently in operation in India integrate larger energy generation technologies into their network (e.g. Husk Power's biomass gasifiers) and some can even power small commercial loads and machines.

In general, the methods which are used to plan and design microgrids to provide energy access for rural populations in developing countries are often ad hoc or rule-of-thumb, similar to the techniques used by the utilities in these areas for their regional network planning. Microgrid entrepreneurs will usually design their systems by hand and size their generation assets based off of the community's anticipated peak load. It is becoming more common nowadays, though, for entrepreneurs to turn to software programs and tools to produce optimally-designed microgrid system configurations. These software programs are able to take many more design considerations and inputs into account than rule-of-thumb guidelines. The list below is a collection of several of the more prominent microgrid design tools out on the market. I will compare each of these tools with LREM's functions and outputs:

HOMER Originally developed at the U.S. National Renewable Energy Laboratory, the Hybrid Optimization of Multiple Energy Resources (HOMER)² microgrid software is the most similar product to LREM, and it is commonly used by system planners all over the world. HOMER attempts to simulate the operation of a viable system for all possible combinations of equipment selected for an entire year. Its optimization algorithm can identify least-cost designs for microgrids or other distributed generation power systems. The tool is also able to take advantage of sensitivity analyses in order to compare many possibilities in a single run and understand the impact of wind speed, fuel costs, etc. on optimal system

¹Often a microgrid may be classified by more categorical names (e.g. mini-grid, pico-grid) based on its system load or generation capacity, but in the context of this thesis the term *microgrid* will be used to refer to all sizes of microgrid systems in order to avoid nuanced system size definitions.

²HOMER is available online at www.homerenergy.com.

designs. Additionally, the tool offers users the option to develop their own algorithm for the microgrid’s operation instead of relying on HOMER’s default optimization algorithm.

Although HOMER offers a greater level of customization of a microgrid (e.g. various generation sources and connected loads) than LREM, it does not build the network for the microgrid. Additionally, it only considers a series of loads at a single aggregated level, while LREM is able to consider distributed loads (e.g. buildings) with various demand profiles. HOMER offers a convenient and user-friendly interface for microgrid design optimization, but it does not offer the level of granularity necessary for planners and builders to comprehensively construct all aspects of a microgrid.

DER-CAM The Distributed Energy Resources Customer Adoption Model (DER-CAM)³ is an economic and environmental model of customer DER adoption which is being developed at Berkeley Lab. The objective of this model is to “minimize the cost of operating on-site generation and combined heat and power systems, either for individual customer sites or a microgrid.” DER-CAM accepts consumer load profiles, electricity tariffs, and CapEx and OpEx costs as constraints; the model then produces the capacity of the system generation assets as well as the economic costs of running the system. DER-CAM’s optimization techniques are robust and sophisticated, but the tool may not be appropriate for use in rural electrification settings. For example, this tool may optimize the microgrid’s dispatch operation to a level of granularity which many rural microgrids cannot realistically be expected to handle. Additionally, this model is solely focused on supply- and demand-side optimization and neglects considering the network which connects loads.

Hybrid2 Hybrid2⁴ is a software tool which is intended to “perform detailed long term performance and economic analysis on a wide variety of hybrid power systems.” The tool was developed to be used by entities interested in the evaluation and design of rural, off grid electrification projects in order to predict hybrid power system performance. Hybrid2 allows for a wide range of technology options, system configurations, and dispatch options. However, the software is no longer supported and has not been updated in many years.

³DER-CAM is available online at <https://building-microgrid.lbl.gov/projects/der-cam>.

⁴Hybrid2 is available online at <http://www.umass.edu/windenergy/research/topics/tools/software/hybrid2>.

3.3 Architecture of LREM

3.3.1 Inputs

LREM requires a series of input data, which is listed below with brief descriptions, to be entered into pre-built templates in order to process a case:

- **Consumers**

1. Geographic coordinates of each household (in UTM coordinate projection with units of meters)
2. Consumer type for each household, where type is an integer value referring to a specified combination of demand patterns
3. Demand specifications of appliances, including their power consumption and average daily duration, used by each consumer type

- **Weather**

1. Hourly PV insolation data of the region to calculate solar generation potential of the area
2. Hourly temperature data of the region to anticipate the usage of certain appliances within specific temperature ranges (e.g. fans will switch on when the temperature is higher than some value set within the consumer demand input file)

- **Financial**

1. Discount rate of investments
2. Average diesel fuel cost in the region
3. CNSE for normal and critical loads

- **Catalogs**

1. Generation catalog, which contains detailed technical and economic information about the available system generation components (e.g. solar panels, charge controllers, battery storage units, converters)
2. Network catalog, which contains detailed technical and economic information about the available network components (e.g. lines, conductors, transformers, protection equipment)

The largest differences in input data between LREM and RREM are that: 1) LREM does not require the layout of any existing network because the model assumes that it will build a microgrid structure from scratch, 2) the electrification status of consumers does not usually influence the final design of a local network to a significant degree because the model assumes that each consumer requires a connection to the microgrid, 3) the cost of

supply of the grid does not influence any generation solutions produced by LREM because the microgrid will utilize only its own generation resources⁵, and 4) parameters related to economies of scale are not needed in LREM since the final solution is always only one single microgrid. However, the accuracy of the location of consumers is an even more important consideration in LREM than RREM because of the detailed nature of designing microgrid networks.

3.3.2 Solution Method

The process which LREM follows to produce an off-grid design for a case can be generalized into the following steps:

1. Receive input files and configurations
2. Invest in appropriate generation technologies (*ogsupply*)
3. Design network configuration (*mgnetwork*)
4. Produce final results

This process, which will be described in greater detail in this section below, is visualized in Figure 3-1.

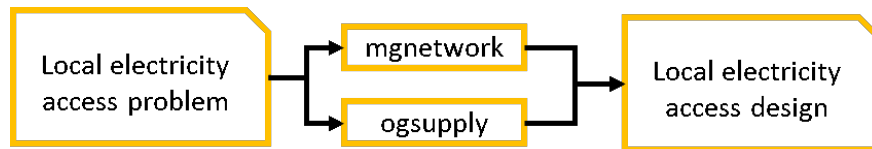

Figure 3-1: Structure of LREM workflow

The model begins by accepting the input data described in Section 3.3.1 from specifically formatted templates. LREM constructs settings and configuration files and also builds demand profiles for each consumer type using the provided input data. It should be noted that the model can consider loads to be specified as either critical or non-critical; if a load is critical (e.g. lights), the system will always try to meet the load’s temporal and energy requirements, while if a load is non-critical (e.g. television), the load will only be met at times when the dispatch strategy has flexibility (e.g. excess energy exists in the system at peak solar production periods).

Next, LREM performs a generation sizing search to identify the generation design which produces the lowest annuity for the lifetime of the microgrid. Depending on user constraints and the cost of the generation assets, the final generation design can include any

⁵Future development of LREM should allow for the capability to consider that microgrids may partially rely on grid-provided electricity (when available) as hybrid grid-microgrid models of electricity supply become increasingly commonplace in the developing world.

combination of solar panels, diesel generators, and battery storage.⁶ The generation assets of the solution are chosen based on the technologies which produce the lowest overall per unit cost of energy; in its search, the model assumes that each asset can be installed in various discrete sizes, as indicated by the generation catalog (e.g. a solar panel array may be composed of multiple units of panels with individual capacities of 0.25, 4, or 10 kW). The solution space produced by LREM parallelizes the optimization of the size of the diesel generator separately from the sizes of the battery and solar panel systems. Additionally, the user-specified dispatch logic of the system (e.g. load-following, cycle-charging) informs the final investment sizing decision of the generation assets in order to ensure that an adequate level of reliability can be maintained for all of the consumers of the microgrid.

In the network design step, which is independent of the generation investment step, LREM relies on the greenfield version of RNM to design a network for the microgrid to reach the community’s households. Greenfield RNM assumes that there is not any existing electrical infrastructure in the area and it proceeds with building all necessary electrical equipment to reliably deliver electricity. Greenfield RNM designs an optimal low-voltage distribution network to connect all of the demand nodes to the position of the generation assets while respecting geographic and technical power system constraints; if the load for the microgrid is particularly large, portions of the network may require medium-voltage or high-voltage line segments. Detailed conductor types, line lengths, and other technical information on the network are produced in the final results.

And finally, LREM simulates the operation of the microgrid’s dispatch strategy with the optimal generation and network designs over a user-specified period of time (e.g. over the course of an entire year). The model produces a series of files and graphs, which are described in Section 3.3.3.

3.3.3 Outputs

After executing the steps of its internal processes, LREM produces a series of output files for each case:

- **Optimal generation mix:** A breakdown of the optimal generation technologies to be used in the microgrid, subject to the specified constraints, and their respective sizes.
- **Estimates of operational performance:** Simulated operation of the microgrid’s dispatch strategy over an indicated period of time.
- **Distribution network design**
 - Shapefiles which provide a visualization of the layout of the network.
 - Detailed summary tables of the network components and their specifications.

⁶Future LREM development efforts should allow for additional generation resources, such as wind power, biomass, or hydropower, to be included in a microgrid’s generation mix.

- **Financial projections:** Annuity, total investment, running costs, expected revenue, and performance metrics which relay reliability.

3.4 Case Study of Bahlolpur Village in India

Motivation of the Work

In January 2017, a microgrid was commissioned for the village of Tayabpur in the region of Vaishali in Bihar, India. The microgrid had been designed by a collaboration between the Universal Access Lab, Tata Power Delhi Distribution Limited, General Electric, and Prayas Juvenile Aid Centre.⁷ The initial planning phases of the microgrid's generation and network configuration were conducted using LREM as a design tool. The purpose of this microgrid was to provide reliable energy access to the local community and also to study the operation of and the community's interactions with the microgrid; the results of future analysis of the Tayabpur microgrid will be used to produce many more off-grid systems designed to provide global energy access. Figure 3-2 provides pictures from the inaugural launch of the Tayabpur microgrid.

⁷A news article describing this unique partnership and the launch of the Tayabpur microgrid can be found at this link: <http://energy.economictimes.indiatimes.com/news/power/tata-power-delhi-distribution-launches-microgrid-project-in-bihar-village/56762805>.



(a) Official event sign



(b) Aerial view of the microgrid's solar panels



(c) Side view of the microgrid's battery and control system housing, diesel generator, and solar panels

Figure 3-2: Launch event of the Tayabpur microgrid, January 2017

The previously mentioned partnership committed to constructing another microgrid in a nearby area within the same Vaishali region in order to provide a second site to study microgrids. This second microgrid, which will be constructed within the next few months, will be located in the village of Bahlolpur on an island in the Ganges River. Pedro Ciller and I undertook the project to apply LREM to Bahlolpur in order to design the generation and network configurations for the village's future microgrid.

Technical Description of the Bahlolpur Case

Bahlolpur is a village of approximately 210 houses and 1,200 residents, all of whom currently are without access to electricity. The village is located on the island of Raghapur in the Ganges River in Bihar, India, as seen in Figure 3-3. The village is a perfect candidate to connect to an independent microgrid because its location on an island makes it prohibitively expensive to provide an extension of the grid to connect its population; in fact, the region's responsible distribution company, the North Bihar Power Distribution Company Limited (NBPDC) intentionally did not include the island in any of its future plans for grid-connected electrification.



Figure 3-3: Google Earth view of Bahlolpur village in the middle of the Ganges River

Using satellite imagery and building identification techniques, the location of the village's buildings were identified (Figure 3-4a), a necessary first step before applying REM to an area. Additionally, the buildings in neighborhoods surrounding Bahlolpur were also identified (Figure 3-4b), in case excess generation from the microgrid could be supplied to nearby consumers. Figure 3-4c outlines the boundary of the Bahlolpur village with respect to the surrounding neighborhoods.

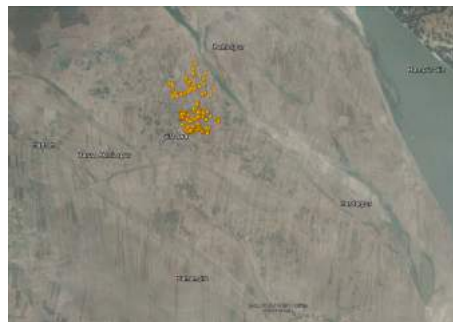

(a) Bahlolpur's buildings



(b) Bahlolpur's and surrounding area's buildings



(c) Outline of Bahlolpur's buildings among the surrounding area's buildings

Figure 3-4: Satellite imagery-derived building locations in the vicinity of Bahlolpur. Courtesy of Stephen Lee.

General Electric is developing a “utility-in-a-box” microgrid infrastructure which contains pre-built generation, storage, and control equipment. Their ambition is to ship this box with pre-built components to a rural village and unpack the microgrid in the intended village with minimal prior calculation and planning effort. To test the effectiveness of this pre-built design in Bahlolpur, the LREM catalogs were constrained to include only the components and sizes used by GE in their utility-in-a-box. The Bahlolpur microgrid’s generation and storage components were constrained to the following sizes in LREM: diesel generation = 15 kW, solar generation = 12 kW, and battery bank = 31.2 kWh. The site of the microgrid’s control, generation, and storage equipment was also constrained to a single, specific site within the village in LREM; this site identification process was mutually agreed upon by the village community and the technology partners.

The capacity of the microgrid’s generation and storage assets is too large for the level of basic demand which each household in the village can be expected to consume and afford. The anticipated initial level of power allotted for each household is 14 W, an amount which would supply one 5 W LED light and one 9 W phone charger; it is possible that some households might demand more power (e.g. wealthier households or farmers who need to power their water pumps) than this initial amount. However, this oversizing in system generation is intended to supply increasing levels of community demand in the future, and potentially to supply the demand of the surrounding villages.

Additionally, while surveying the population of Bahlolpur, each household indicated their preference for desired hours of supply of electricity. The majority of households specified that six hours of constant and reliable supply in the evening time was sufficient for their needs. In comparison, electricity supplied by the grid to other rural villages in Bihar is typically intermittent and irregular. Providing reliable electricity in pre-defined intervals of time is an enormous advantage which well-built microgrids can have over the electrical grid in countries like India, where the grid has significant reliability issues. In order to efficiently design the microgrid, the households of Bahlolpur were divided into three different categories based on their desired hours to receive the supply of electricity:

- **Type A:** *170 households*, 5 PM to 11 PM
- **Type B:** *30 households*, 9 AM to 5 PM & 5 PM to 11 PM
- **Type C:** *10 households*, 9 AM to 5 PM

Sensitivity Analysis Results: Adjusting System Load

Depending on the defined input conditions used to run LREM, the model will produce different results. In this final section detailing the application of LREM to construct a microgrid for Bahlolpur, various possible solutions are presented, where each solution depends on the magnitude and hours of anticipated household demand. Microgrid developers can use LREM

as a sensitivity analysis tool to gauge the impact which certain variables have on the model's outputs, and then ultimately select the optimal configuration for the given situation (e.g. minimum cost system or one which provides the greatest level of reliability). In the case of Bahlolpur, the partnership between the previously listed companies relied on these sensitivity analysis results to select the final configuration of the microgrid. And, as mentioned earlier, each of these presented cases optimizes the solution around constrained generation and storage capacities, although LREM can optimize the capacity of these components if desired by the user of the model.

The magnitude of the overall system load will impact system costs. In Figure 3-5, the reference case for Bahlolpur, the three consumer types in the village each consume 14 W of power (i.e. 2 LED lights and a phone charger) at their previously indicated time intervals. As seen by the exclusive reliance on solar and battery systems in the dispatch plot of Figure 3-5a, LREM determines that solar generation (yellow-colored shape) and storage (blue-colored shape) are adequate to supply 100% of the overall system demand. The network layout of the microgrid for this case is illustrated in Figure 3-5b, where the orange triangle indicates the position of the pre-defined site of generation. The computed volumetric charge for this particular configuration is \$0.87/kWh and the overall total system cost, which can be seen in the second to last row of Figure 3-5c and includes the complete costs of generation and network assets, investment, and operation and maintenance, is \$5,318 per year.

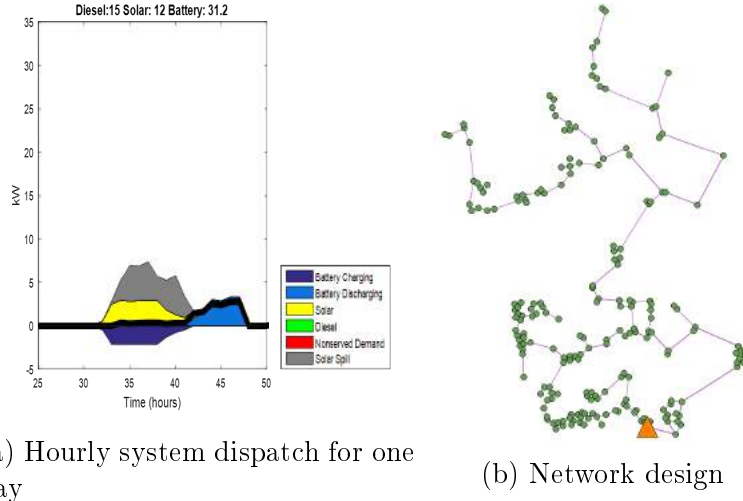

(a) Hourly system dispatch for one day

(b) Network design

Solar (kWp)	12
Battery (kWh)	31.2
Diesel (kW)	15
Solar total annual cost (\$/yr)	997
Solar investment annual cost (\$/yr)	913
Solar O&M annual cost (\$/yr)	84
Diesel total annual cost (\$/yr)	524
Diesel investment annuity (\$/yr)	347
Diesel O&M annual cost (\$/yr)	176
Diesel fuel annual cost (\$/yr)	1
Battery total annual cost (\$/yr)	1,716
Battery investment annuity (\$/yr)	1,603
Battery O&M annual cost (\$/yr)	112
Cables/Combined box total annual cost (\$/yr)	122
Cables/Combined box investment annual cost (\$/yr)	122
Integrated Energy Management System total annual cost (\$/yr)	81
Integrated Energy Management System investment annual cost (\$/yr)	81
Total demand served (kWh)	6,123
Fraction of demand served (%)	100.0
Diesel usage (%)	0.0
Annual network cost (\$/yr)	1,878
Network investment annual cost (\$/yr)	1,283
Network O&M annual cost (\$/yr)	595
Total length of the network (km)	10.0
Annual investment cost (\$/yr)	4,349
Annual O&M cost (\$/yr)	968
Annual generation cost (\$/yr)	3,440
Total cost [generation, network, investment, O&M] (\$/yr)	5,318
Total sustainable cost [total cost - investment cost + battery investment cost] (\$/yr)	2,572

(c) Case parameters and system costs

Figure 3-5: Bahlolpur microgrid design for demand x1 (A, B, & C)

However, if the magnitude of the system load is adjusted, then the technical- and financial-related aspects of the solution shift. For instance, as shown in Figure 3-6, the overall system demand is increased such that the original demand by consumers of Type A is multiplied by 4 (Type A = 56 W), Type B is multiplied by 2 (Type B = 28 W), and Type C is multiplied by 2 (Type C = 28 W). In application, this increase in demand for electricity across the entire community would occur if each household realized the benefits of increased energy access and could afford the cost of additional supply. The increased system load has an effect on multiple aspects of the microgrid design: Figure 3-6a shows that the diesel generator (green-colored shape) is now needed to supplement the generation from the solar and battery systems due to the increased load in the evening time after the sun has gone down. Figure 3-6c indicates that additional lines are required to provide a reliable supply of electricity in the new network configuration, the volumetric charge is now reduced

to \$0.59/kWh because of greater energy utilization, and the total system cost has increased to \$12,400 per year to account for diesel usage and greater utilization of other components of the system.

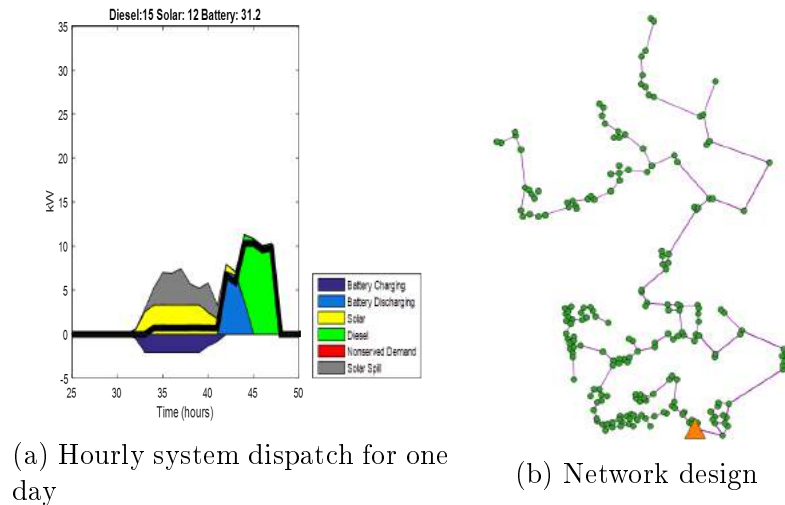

Solar (kWp)	12
Battery (kWh)	31.2
Diesel (kW)	15
Solar total annual cost (\$/yr)	997
Solar investment annual cost (\$/yr)	913
Solar O&M annual cost (\$/yr)	84
Diesel total annual cost (\$/yr)	6,134
Diesel investment annuity (\$/yr)	389
Diesel O&M annual cost (\$/yr)	176
Diesel fuel annual cost (\$/yr)	5,569
Battery total annual cost (\$/yr)	1,917
Battery investment annuity (\$/yr)	1,805
Battery O&M annual cost (\$/yr)	112
Cables/Combined box total annual cost (\$/yr)	122
Cables/Combined box investment annual cost (\$/yr)	122
Integrated Energy Management System total annual cost (\$/yr)	81
Integrated Energy Management System investment annual cost (\$/yr)	81
Total demand served (kWh)	20,989
Fraction of demand served (%)	100.0
Diesel usage (%)	0.0
Annual network cost (\$/yr)	3,149
Network investment annual cost (\$/yr)	2,509
Network O&M annual cost (\$/yr)	640
Total length of the network (km)	10.7
Annual investment cost (\$/yr)	5,819
Annual O&M cost (\$/yr)	6,581
Annual generation cost (\$/yr)	9,251
Total cost [generation, network, investment, O&M] (\$/yr)	12,400
Total sustainable cost [total cost - investment cost + battery investment cost] (\$/yr)	8,386

(c) Case parameters and system costs

Figure 3-6: Bahlolpur microgrid design for demand x4 (A), x2 (B), x2 (C)

And finally, to illustrate an extreme example of increased demand within the village, Figure 3-7 demonstrates the result when the overall system demand is significantly increased such that the original demand by consumers of Type A is multiplied by 14 (Type A = 196 W), Type B is multiplied by 7 (Type B = 98 W), and Type C is multiplied by 7 (Type C = 98 W). This enormous increase in demand would not be likely to occur in a real scenario, but this example is intended to show the dangerous consequences of improperly sizing a microgrid without prior understanding of the potential load for the system. The dispatch during a day (Figure 3-7a) now requires significant reliance on the diesel generator, but the total system generation and storage capacity is not able to meet all of the demand in the evening time,

which results in non-served demand (red-colored shape). Additionally, the volumetric charge has decreased to \$0.48/kWh because of a high rate of energy utilization, but the total system cost has increased to \$19,568 to reflect additional network and generation costs. And, as noted in Figure 3-7c, only 60.9% of the total demand is served by the microgrid, which is a serious reliability issue.

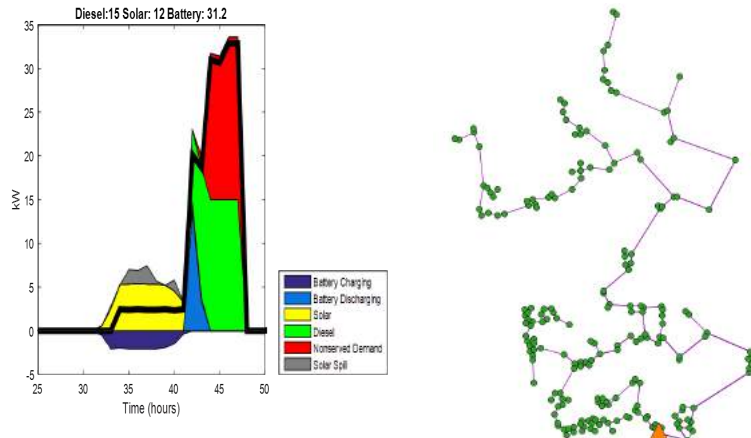

(a) Hourly system dispatch for one day

(b) Network design

Solar (kWp)	12
Battery (kWh)	31.2
Diesel (kW)	15
Solar total annual cost (\$/yr)	997
Solar investment annual cost (\$/yr)	913
Solar O&M annual cost (\$/yr)	84
Diesel total annual cost (\$/yr)	11,710
Diesel investment annuity (\$/yr)	446
Diesel O&M annual cost (\$/yr)	176
Diesel fuel annual cost (\$/yr)	11,088
Battery total annual cost (\$/yr)	1,839
Battery investment annuity (\$/yr)	1,727
Battery O&M annual cost (\$/yr)	112
Cables/Combined box total annual cost (\$/yr)	122
Cables/Combined box investment annual cost (\$/yr)	122
Integrated Energy Management System total annual cost (\$/yr)	81
Integrated Energy Management System investment annual cost (\$/yr)	81
Total demand served (kWh)	40,537
Fraction of demand served (%)	60.9
Diesel usage (%)	65.5
Annual network cost (\$/yr)	4,819
Network investment annual cost (\$/yr)	4,085
Network O&M annual cost (\$/yr)	734
Total length of the network (km)	12.3
Annual investment cost (\$/yr)	7,374
Annual O&M cost (\$/yr)	12,194
Annual generation cost (\$/yr)	14,749
Total cost [generation, network, investment, O&M] (\$/yr)	19,568
Total sustainable cost [total cost - investment cost + battery investment cost] (\$/yr)	13,921

(c) Case parameters and system costs

Figure 3-7: Bahlolpur microgrid design for demand x14 (A), x7 (B), x7 (C)

These results illustrate the breadth of impact of various magnitudes of loads on the final microgrid design. Allowing too large of a load to be connected to the system (e.g. Figure 3-7) may result in sub-optimal operation of the microgrid with non-served demand; this situation might occur if nearby neighborhoods begin connecting to the microgrid. However, Figure 3-6 demonstrates that there is enough excess capacity in the Bahlolpur microgrid's generation and storage assets to allow each of the village's households to consume beyond the initial 14 W per household value, and the microgrid will still continue to operate normally.

Chapter 4

Estimating the Electrification Status of Buildings and a Case Study in Uganda

Elements of the work presented in this chapter were conducted in collaboration with fellow members of the Universal Access Lab. I inherited this work when the approach within REM to estimating the electrification status of buildings was utilizing circles of varying radii, as described in Section 4.3.1. I then produced the results described in Sections 4.3.2 and 4.3.3 with the help of Claudio Vergara. Next, Stephen Lee and I jointly designed the ground-based survey in Uganda described in Section 4.4, carried out by GIZ-Uganda in September and October 2016. Stephen’s most recent result based on Gaussian processes is presented at the conclusion of this chapter to illustrate the developing improvements to this endeavor.

4.1 Overview Description of the Estimating Electrification Status of Buildings

Access to energy is not a straightforward concept in many areas of the developing world. When discussing energy access situations, a differentiation should be made between access to the supply of energy, access to services resulting from the supply, and actual usage of the supply. To examine the many models of energy access leading to electrification, it is necessary to ask critical questions like, “Can access to unreliable energy truly be deemed *access*?” and “How much energy is needed to *fully* enable poverty alleviation?”

Dissecting the Definition of Energy Access

Maithani and Gupta define energy access as

"the physical availability of modern energy carriers and improved end-use devices at the household level at affordable prices. It includes access to less polluting household energy for cooking and heating, or electricity for powering appliances and lights in households and public facilities, which could come from renewable sources, and mechanical power from either electricity or other energy sources that improve the productivity of labor." [19]

Balachandra provides the nuanced distinction that,

"Conceptually energy access means that modern energy services should be physically accessible and available to the people, should be of acceptable quality, reliability and preference, should be affordable both in terms of low capital and operating cost and in the context of income levels, and finally it should be adequate in terms of abundance." [20]

Pachauri adds to these definitions by considering energy access to include the summation of availability, acceptability, adequacy, affordability, reliability, and quality of supply. [21]

To provide quantitative structure to these statements, the IEA defines initial energy access as 250 kilowatt-hours (kWh) per year for rural households and 500 kWh per year for urban households; it also projects that this basic level of access will increase to 800 kWh per person by 2030 [22]. However, it is worth making the comparison that the IEA's definition of basic access is far lower than the level deemed to be considered "modern" energy access. For example, 250 kWh per capita per year is 22 times less than the average European's energy usage (5,391 kWh per capita per year) and 48 times less than the average American's (12,077 kWh per capita per year) [23].

The World Bank expanded upon the idea of energy access classification and relied on Sustainable Energy for All's (SE4All) Global Tracking Framework [3] to classify household energy access on a more detailed basis. Table 4.1 from World Bank data categorizes households into different tiers based on their degree of electricity consumption. In their model, the World Bank considers situations with energy accessibility below the 250 kWh threshold because these low levels of access are common in many areas of the world.

	Tier 0	Tier 1	Tier 2	Tier 3	Tier 4	Tier 5
Annual consumption levels (kWh)		≥ 4.5	≥ 73	≥ 365	$\geq 1,250$	$\geq 3,000$
Daily consumption levels (Wh)		≥ 12	≥ 200	$\geq 1,000$	$\geq 3,425$	$\geq 8,219$

Table 4.1: World Bank multi-tier matrix for measuring access to household electricity supply. Adapted from [24].

The definitions provided by the World Bank and the IEA for energy access are commonly cited and used, but many other actors in the energy access space have their own

definition for what is meant by “energy access.” World Bank data in Figure 4-1 demonstrates the wide range of what is meant by “energy access” using data from many different countries. The figure also illustrates how per capita energy consumption differs between the countries which are considered fully electrified and those which are largely unelectrified. Having full access to energy does not necessarily mean having access to *modern* energy services [21]. Instead of a blanket approach to solving energy access, diversified business models and technology options must be used to address the nonhomogeneous nature of electrification.

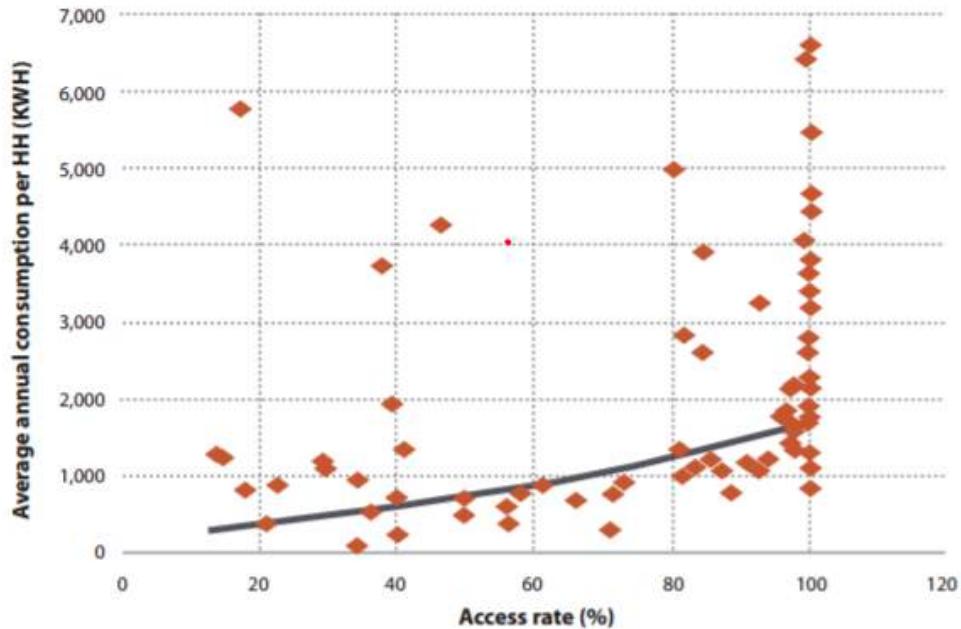

Figure 4-1: Range of average annual household energy consumption (kWh) across countries with various degrees of ‘energy access.’ Reprinted from [21].

In addition to classification based on level of energy consumption or supply, access to energy can be further categorized by regional variations which affect the development of energy infrastructure. For example, in Sub Saharan Africa there are, in general, many clusters of non-electrified houses at great distances from each other and the existing grid. In Latin America, in contrast, there is a smaller number of mostly isolated rural communities. And in India, numerous non-electrified houses exist in densely populated areas close to or under the grid. Furthermore, many households in areas across the world with a high official rate of energy access may still lack access, which points to a myriad of problems with the responsible utility and government. For example, the Indian government’s official Rural Electrification Policy of 2006 considers a rural village electrified if basic electrical infrastructure (e.g. transformer) is established and its main public buildings and 10% of the contained households have connections to an energy supply. What of the remaining 90% of households within the village without connections, or even the fact that availability through these connections to the grid may only be for a few sporadic hours each day? These global

differences in electrification situations make the possibility of applying a one-size-fits-all electrification scheme to the energy access challenge impractical.

Data on Electrification Status

An understanding of the complexity of global energy access situations is necessary to plan out an appropriate and efficient electrification design for a region's buildings without access to energy. In order to use either RREM or LREM to plan an electrification design for an area, it is necessary to know exactly where the buildings with and without energy access are located, as well as what their anticipated energy demand might be once they're provided with a connection. Accurate information is fundamental in constructing an efficient network design which connects all unelectrified buildings while avoiding the possibility of constructing a redundant set of lines to buildings already connected to the grid.

However, granular and exact data on building-level electrification status conditions is oftentimes limited in the areas of the world which have the greatest need for energy access improvements. In particular, data on building-level energy access conditions and the location of the low-voltage network, the two datasets which would best inform the question of regional electrification status, are not commonly recorded in the developing world. Knowing the electrification status of each building in a region (either connected to some electricity supply, or not) allows planners to decide how to efficiently use scarce resources in order to maximize impact and reduce the risk of infrastructure cost under-recovery.

This chapter addresses the current approach used within REM to estimate which buildings have access to and which buildings lack access to energy. This chapter will also point to continued efforts in this space as the work advances and new techniques and datasets are utilized. It is worth emphasizing that the best case scenario for rural electrification planning uses accurate and reliable data on building locations and electrification status, but in the event that electrification planning efforts face a high degree of uncertainty, the methods described in the subsequent sections of this chapter can help to provide the best estimation available in order to inform planning efforts.

4.2 Literature Review on Estimating the Electrification Status of Buildings

Multiple studies, such as [25], [26], and [27], have made use of the National Oceanic and Atmospheric Administration's (NOAA) Defense Meteorological Satellite Program Operational Linescan System (DMSP-OLS) nighttime lights imagery to detect economic activity and energy access on large-scale regional levels. These studies prove the effectiveness of using the

nighttime lights dataset to derive macro-level energy-population relationships, but they do not provide results of a granularity which would support electrical network planning models.

Doll and Pachauri in [28] are able to utilize nighttime lights in combination with population datasets to estimate the size of rural populations across the world without access to electricity. Later, Doll in [29] assesses the likelihood that a single pixel within the nighttime lights data set would contain light emissions based on the population density within the respective area of the pixel. These estimations and predictions are informative in determining the general state of rural electrification within a developing country.

Min et al. in [30] use DMSP-OLS nighttime light output to identify electricity access on a village-level granularity in Senegal and Mali. These authors are able to demonstrate that nighttime lights can be used to differentiate electrified from unelectrified villages in rural and developing areas, but they note that the correlation between nighttime lights output and household electricity access and usage is low in their study. Then, Min and Gaba in [31] are able to quantify the relationship between an increase in nighttime light output and the number of additional streetlights or electrified homes developed within villages in Vietnam. These studies offer inferences of electrification status at village-level detail.

Lee et al. in [32] surveyed households in Kenya which were within viable connectivity distances from transformers to determine if the buildings had a visible electrical connection to the grid. The authors found that the majority of unconnected households were close to a connection point, and also that a household's likelihood of being connected increased only slightly as its proximity to the nearest transformer decreased. By determining that the households within this case study which were located near the electrical network or a transformer (a phenomenon termed "under grid") often did not have a connection, this research demonstrates that transformer and electrical network locations may not be the most effective indicators of electrification status. The authors are also able to prove that in their Kenya dataset a household is more likely to be electrified if it is considered to be "well-off."

4.3 Approaches to Estimating the Electrification Status of Buildings

The methodology to estimate the electrification status of buildings in rural and developing countries within REM has evolved over a series of iterations, and it is continuing to evolve in order to improve the accuracy of the results. A short summary will be provided in this section of each of the past and current approaches. The common first step in each of these approaches is obtaining the geographic location of buildings (without their electrification status properties). Sometimes this information can be obtained from a local utility, NGO, or government agency, but when this is not a possibility, other means of gathering building

locations are necessary; manual on-the-ground surveying or automatic extraction of building locations using satellite imagery are possible extraction techniques.¹

Next, the building locations must be compared with other factors and available data points to calculate a likelihood that a specific building has a connection with the grid. It is currently assumed that a building which has been determined to be electrified (i.e. has a connection to a network, has access to the fully-desired levels of energy supply and does not need to be included in future electrification efforts). However, as noted in earlier sections, access to the grid or other forms of energy supply does not necessarily guarantee full supply of the desired levels of electricity; it will be the responsibility of the region’s electrification planners to ensure that all households have full energy access in order to facilitate human development.

4.3.1 First Approach: Circles around Distribution Transformers

The initial approach to address the activity of estimating building-level electrification status, which was developed by Doug Ellman and Claudio Vergara [9], was to assume that buildings within a defined radius of a transformer were electrified (see Figure 4-2), while those outside of the radius were assumed to be unelectrified. The radius for all transformers was sized so that the total number of electrified buildings in an area matched up with the official count of electrified buildings for that area (e.g. the Census of India and the National Sample Survey provided electrification records of India).

This technique was rudimentary but served as a first approximation to characterize electrification patterns. Lee et al. in [32] point out that proximity to transformer locations may not be a reliable indicator of electrification status, at least in Kenya.

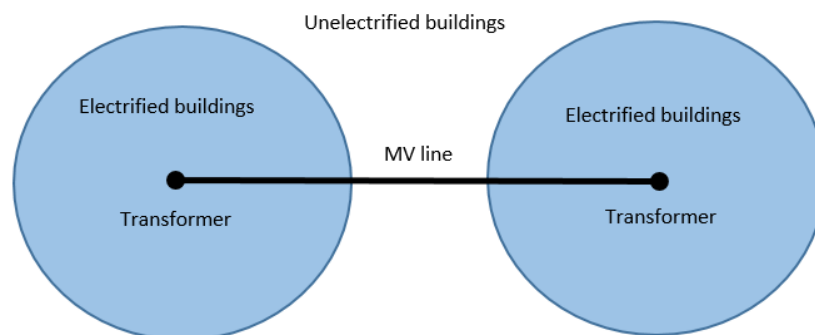

Figure 4-2: First approach to estimating the electrification status of buildings

¹For additional information on this last option--automatically identifying buildings with satellite imagery--and its incorporation into the Universal Access Lab’s workflow, refer to Stephen Lee’s thesis (to be published).

4.3.2 Second Approach: Artificial Low Voltage Networks

To improve upon the rudimentary nature of the first approach, a reasonable, though artificial, low-voltage distribution network was developed for the region of study. The low-voltage lines of an electrical network can adequately inform the question of estimating the electrification status of buildings, but they are a dataset which is not commonly available or procurable in the developing world, though medium- and high-voltage distribution line positions are generally known. The hypothesis in this approach was that it would be more accurate to consider buildings located along the branches of a low-voltage network to be electrified rather than within a generic, encompassing circle. To this end, three different low-voltage network designs were created which extended 500 meters in length.²

Figure 4-3 illustrates the configuration of one of these three designs, where Segment 8 in the bottom-right corner of the figure is affixed to a MV/LV distribution transformer (red circle) along a medium-voltage line (orange line), and the remaining segments of the design extend in a direction away from the transformer. For each MV/LV distribution transformer in the region, one of these three designs was randomly selected and placed at the base of the transformer, then the design was rotated at some random angle between 0 and 360° around the base of the transformer. This variation in low-voltage network designs and the angle at which the design branched out from a transformer was intended to artificially provide stochasticity to the activity of estimating electrification status.

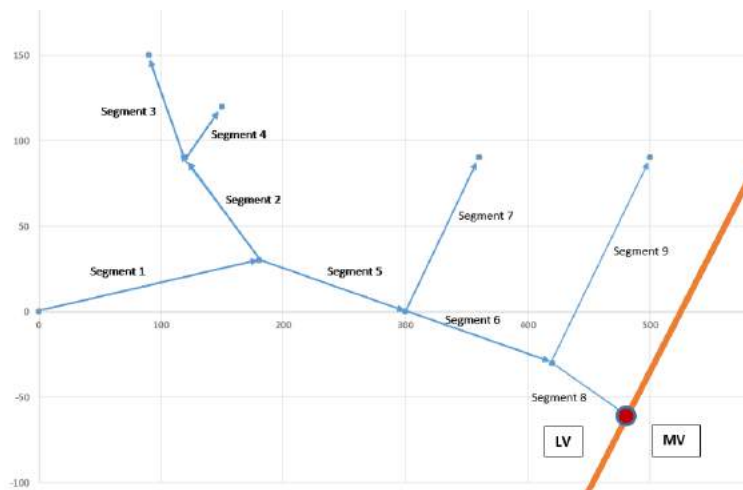
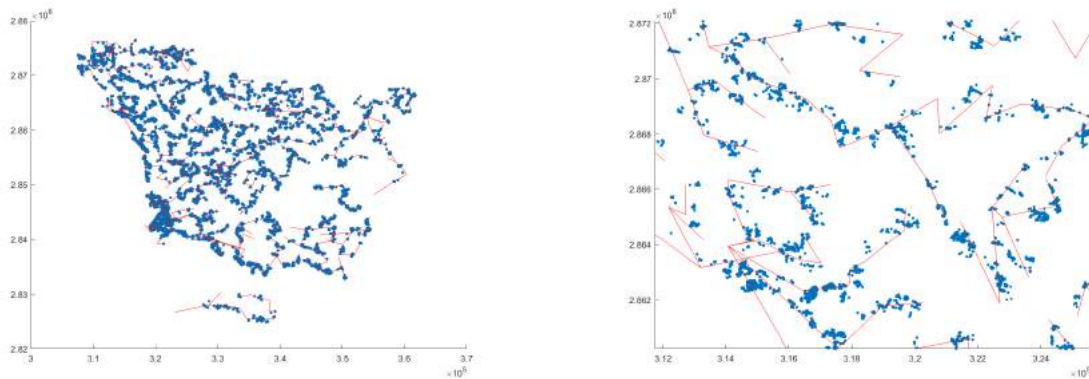

Figure 4-3: Second approach to estimating the electrification status of buildings

This approach using artificial low-voltage networks to estimate building-level electrification status produced results which, at least visually, resembled a more accurate representation of networks. However, the artificial and static nature of this approach was not able

²This distance was selected to be an average representative distance of electrification from a transformer, primarily because of the significant voltage drop issues which occur far away from a transformer.

to utilize the actual position of existing low-voltage lines nor did the lines follow the layout of buildings in the area. Results of this approach applied to the region of Vaishali in Bihar, India, which has around 600,000 buildings, can be seen in Figure 4-4, where the blue dots represent identified electrified buildings and the red lines represent existing MV sections of the network. The image on the left represents the buildings within the entire region which this approach determined to be electrified, while the image on the right presents a zoomed-in view of a smaller section of the region. Notice that the electrified buildings are located around the medium-voltage lines along which the distribution transformers are positioned.



(a) Electrified buildings and the MV network

(b) Zoomed-in view of a smaller area

Figure 4-4: Second approach to estimating the electrification status of buildings applied to the Vaishali region of India

4.3.3 Third Approach: Score-based Estimation

The first two presented approaches did not reflect conditions on the ground or rely on any data except for the position of transformers and the distribution network. Though not necessarily accurate at predicting building electrification status, they provided a means to begin approximating the previously unknown electrification status of buildings. In this third iteration of estimating the electrification status of buildings, the last version of this project which I have been involved with, additional datasets are considered in order to build a more comprehensive distribution of electrified versus unelectrified buildings. An example of this score-based approach, in which buildings that are located closer to electrification indicator variables receive a higher weight, will be demonstrated in Section 4.4.

The position of the known transformers and distribution network are used in combination with 2013 DMSP-OLS nighttime lights imagery as predictor variables to inform the building-level electrification status. The nighttime lights dataset, which was described in Section 4.2 as being used in previous studies to detect regional economic activity and village-level electrification status, provides a spatial distribution of lights which can serve

as a proxy for the location and degree of electricity consumption of human settlements. However, [28], [30], and [31] note the limitations of nighttime lights in identifying rural populations for various reasons: Household electricity usage in rural and developing regions is typically low and dispersed, electrified villages may not have any outdoor street lighting, and/or low levels of light output may be filtered out by nighttime composite images or be too minute to be detected by satellite sensors.

In this approach, a buffered area of 500 meters is drawn around each distribution transformer and an area of 50 meters is drawn on either side of the high- and medium-voltage distribution lines. The buffered area is intended to represent a probable distance from each of these structures in which a building within these areas would likely have energy access. However, proximity to local infrastructure (i.e. transformers, electrical lines) does not necessarily ensure energy access, for reasons such as inactive or destroyed transformers.

Therefore, the DMSP-OLS nighttime lights dataset, which represents surface-level resolution at or near one kilometer resolution, is layered on top of the network layout and transformer positions. Each pixel of the nighttime lights imagery represents a level of nighttime illumination for an area, and the intensity of the pixel typically corresponds to the level of development and human density existing within its area. The brightness of a particular pixel can range from an average digital number (DN) value of 0 to 63 [29]. For simplification purposes for this work, pixel values are assumed to be binary, whereby any DN value above 0 is considered to represent visible electrified activity, and a value of 0 represents no electrification presence within the pixel's area.

Different weights are placed upon each electrification status predictor variable in order to categorize the level of certainty that a building adjacent to any of these predictor variables may be electrified. For example, the buffer zone around a line may represent a value of 0.1 , a transformer 0.3 , and bright nighttime lights pixel 0.6 . These weights are somewhat arbitrary, but they reflect the potential for a predictor variable to correspond with positive electrification status and can be changed to match the context of the situation; in this regard, proximity to a bright nighttime lights pixel is likely to be the most reliable determinant of electrification status. Then, the available set of building positions is compared against these predictor variables and their buffered locations. A scored value is calculated for each individual building with respect to their proximity to predictor variables. For example, a building which is within the radius of a transformer as well as in a bright nighttime lights pixel will receive a scored value of 0.9 .

The total list of buildings is sorted in descending order in terms of their scored values. An official record of the region's number of electrified buildings or percentage of electrification is used to select the buildings with the highest probability of being electrified. For example, if a region's electrification rate is 25%, then the first 25% of buildings on the list with the highest probability of being electrified are considered to be electrified, and the remaining

buildings are considered to be unelectrified.

This score-based estimation approach to determine building-level electrification status considers the real situation on the ground by utilizing the bright pixels of the nighttime lights dataset in tandem with electrical lines and transformers. Furthermore, its results are more accurate than the previous approaches in the sense that the buildings determined to be electrified don't all group around transformers and lines. Instead, the weight-based metric system allows for the possibility that electrification patterns may be distributed, which is often the case in real situations. The limitations of this approach include the reliance on an official and reliable record of electrification rates and the selection of the weights to be placed upon each electrification status predictor variable. Example results of this approach are illustrated in Figure 4-8 in Section 4.4.

4.3.4 Next Steps Forward

In order to utilize accurate and reliable data on building locations and electrification status, the Universal Access Lab in coordination with Deutsche Gesellschaft für Internationale Zusammenarbeit (GIZ)-Uganda designed and conducted an electrification status survey for 472 buildings in the Uganda South Service Territory (SST)³ in late 2016. This survey relied on enumerators to go out into the field and determine whether residents in 472 buildings distributed over the SST had a connection to an energy source. These results will be introduced into Gaussian Process Classifiers (GPCs). An uncertainty surface can be produced and surveying can be prioritized in areas of high uncertainty. Refer to Stephen Lee's research for these techniques applied to the activity of estimating building electrification status.

Future work will need to address the following concerns about this activity and relevant datasets:

- The most recent and available DMSP-OLS nighttime lights imagery is from the year 2013. Unless an updated dataset is produced and shared, estimation efforts of electrification status may be outdated, particularly considering the rapid pace of present electrification efforts.
- The task of estimating building-level electrification status should not realistically assign a simple binary metric (i.e. "0" to indicate without access to electricity, "1" to indicate access to electricity) to each building in a region. As discussed earlier in the chapter, access to energy is not a straightforward concept in the developing world. For example, an increasing number of households are adopting solar lanterns and kits as energy solutions because of these devices' affordability and widespread availability; however, these basic solar solutions are not able to provide households with a level of energy

³The Uganda Rural Electrification Agency (REA) has partitioned the country into 13 electricity distribution service territories.

access that could be deemed “modern” or be categorized within one of the World Bank’s higher tiers of energy access in Table 4.1. Therefore, it would be more appropriate to define the electrification status of buildings on some kind of sliding scale, where the closer a household is to 0, the higher the priority for the responsible electrification agency to provide a solution for that household should be.

- Estimation of electrification status approaches should take into account the possible effect of a neighbor’s electrification status on surrounding buildings. For example, it is likely the case that a neighbor with energy access will share that access with the surrounding buildings, a phenomenon which may not be well-represented in the available datasets.

4.4 Case Study of the SST in Uganda

Data on building-level electrification status is sparse to nonexistent in Uganda, a country with a population of 39 million people, while only 19% of the population has access to electricity, as of 2014 [1]. The contrast between rural and urban accessibility of electricity is apparent: Only 12% of the rural population has electricity access, while 52% of the urban population has access [1]. This research began as a result of the need for collecting the electrification status of buildings in the South Service Territory, or the extreme southern area of Uganda. The area of the SST is displayed in red with respect to the rest of the country in Figure 4-5.



Figure 4-5: Google Earth view of the South Service Territory (SST) in Uganda

The SST was, by official records, approximately 11% electrified at the time of this work, although building-by-building level electrification information did not exist [33]. Therefore, the score-based estimation approach described in Section 4.3.3 was applied to the SST to build a mapping of electrified versus unelectrified buildings.

The first step in this process was obtaining the location of all buildings using image detection algorithms and satellite imagery. Figure 4-6 illustrates the results of this building extraction effort: The apparent lack of buildings on the eastern part of the territory is due to the edge of the waters of Lake Victoria, while the gaps in the central and western sections of the territory are attributed to the unavailability of comprehensive satellite imagery. GIZ-Uganda manually corrected for the absence of building data in the central area of the SST by using Google Earth as a reference tool and adding new buildings to the existing building dataset.

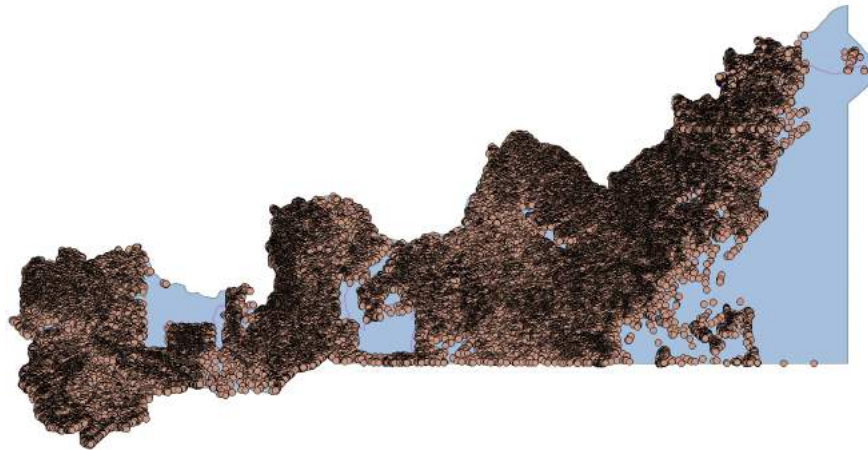

Figure 4-6: All buildings (386,000) in the SST of Uganda

4.4.1 Score-based Estimation Applied to this Case Study

The building dataset was compared against the location of the transformers, distribution network, and bright pixels of the nighttime lights dataset within the SST. These three predictor variable layers are displayed in Figure 4-7, where the white patches represent nighttime lights pixels with DN values greater than 0, the green lines represent the distribution network, and the blue circles represent distribution transformers. Bright pixels of the nighttime lights were given a probability weight of 0.6 , the area around the network 0.1 , and the area around transformers 0.3 . When the score-based value of being electrified had been calculated for each building in the dataset, the 11% of the buildings with the highest score were selected to be electrified so as to correspond with the officially recorded electrification rate of the territory.

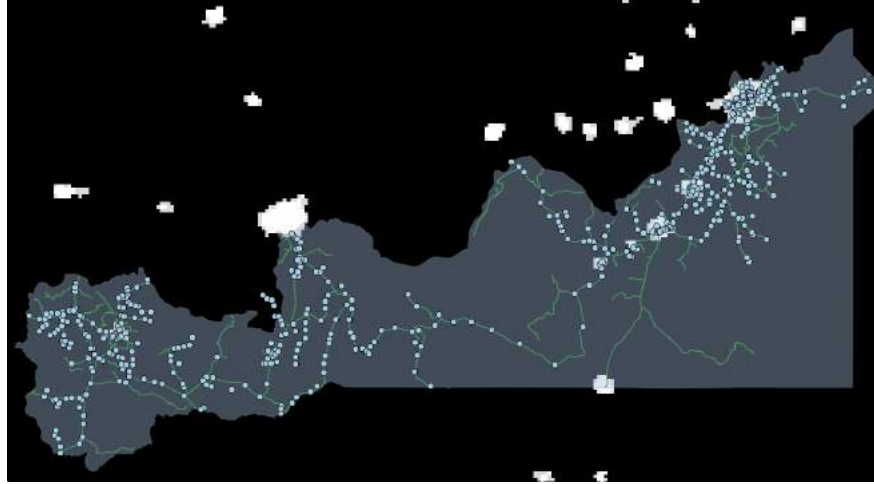
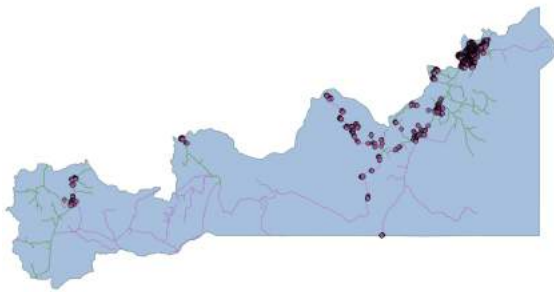
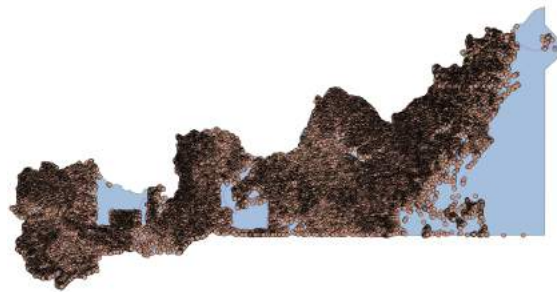

Figure 4-7: DMS-OLS nighttime lights layer superimposed over SST of Uganda

The results of this analysis are displayed in Figure 4-8. The 42,454 buildings deemed to have energy access are shown as purple-colored points on the left, while the remaining 343,547 buildings without access are shown as brown-colored points on the right. Though they represent only a fraction of the total buildings in the territory, the electrified buildings are distributed across the territory and their locations correspond most strongly with areas dense with transformers, electrical lines, and nighttime lights bright spots.



(a) Electrified buildings



(b) Unelectrified buildings

Figure 4-8: Third approach to estimating the electrification status of buildings applied to SST of Uganda

Some of the inadequacies of this approach are apparent in these above figures: For instance, the weights of each of the indicator variables need to be adjusted so that some electrified buildings appear around the positions of distribution transformers in the central and western parts of the territory.

4.4.2 Gaussian Processes Applied to this Case Study

As mentioned at the start of this chapter, Stephen Lee has been working to apply probabilistic approaches to the task of estimating building-level electrification status. His latest results, which utilize Gaussian processes, are presented below in Figure 4-9 in order to illustrate the improvements in accuracy that have already occurred in this task. The purple-colored points in the figure on the left represent electrified buildings, the brown-colored points in the figure on the right represent unelectrified buildings, and the green line represents the layout of the electrical distribution network. Notice how the electrified buildings in Figure 4-9a are distributed across the entire territory and map against the concentration of nighttime lights hotspots and electrical infrastructure. Additionally, the empty sections of the territory missing buildings in previous figures have been corrected with several of Stephen's techniques. Results from this estimation of electrification status task will continue to be improved as research progresses in this area.

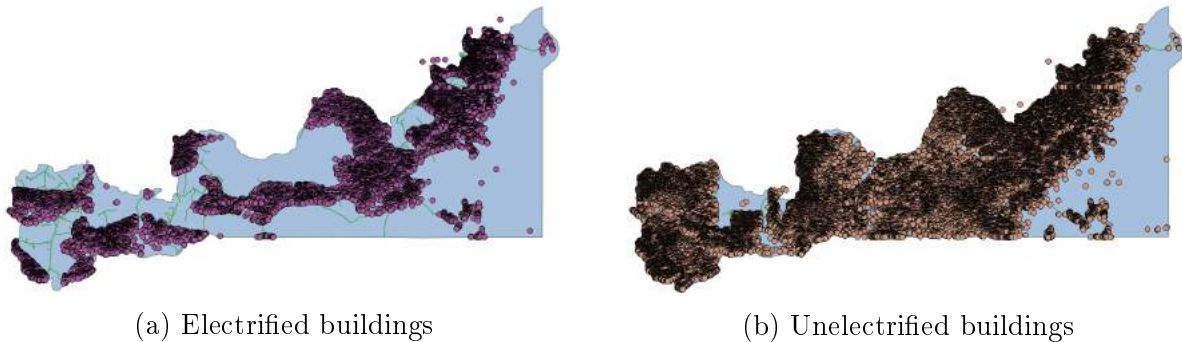

Figure 4-9: Gaussian processes applied to SST of Uganda. Courtesy of Stephen Lee.

Chapter 5

Calculating Upstream Network Reinforcements and a Case Study in Rwanda

I'd like to thank Claudio Vergara for helping guide my approach to this work, Fernando de Cuadra for framing the theory surrounding the concept of upstream network reinforcements, and Carlos Mateo for modifying the Brownfield RNM executable files so that I could produce definitive results.

5.1 Overview Description of Upstream Network Reinforcements

In a progressive rural electrification effort, significant levels of new demand (i.e. thousands of newly connected consumers) may be connected to the existing electrical grid. The existing grid may not be equipped to effectively accommodate these new loads, depending on the location and magnitude of the new interconnections. As a result, system reliability could be affected, unless either the magnitude of the load is decreased (i.e. curtailments) or new investments in the network (i.e. reinforcements) can be implemented.

Network reinforcement projects applied at the distribution level of an electric power system can include:

- Installation of new transformer
- Addition of capacitor bank
- Upgrade of limiting bus or breakers
- Replacement of limiting cable sections

- Establishment of new area substation [34]

Upstream reinforcements are also relevant at the transmission and generation levels of an electric power system (e.g. a new load may be significant enough that additional generation is needed in the system to meet its entire demand). However, the current focus of this research project is exclusively on network reinforcements at the distribution level because this work is integrated within the workflow of REM, which is a planning tool exclusively focused on distribution-level designs.

In the current status of REM, the user of the model specifies a grid-energy cost as an input value, a cost which groups several components into a volumetric energy charge (\$/kWh). The hypothesis proposed in this chapter is that if the network reinforcement costs included within the energy charge can be explicitly calculated, it could be possible to make more efficient electrification decisions at the step within REM which compares on-grid and off-grid solutions. Explicitly incorporating this network reinforcement cost into electrification strategies as a cost driver may alter final project costs and, as a result, may influence the decision between grid expansion and off-grid solutions. The Upstream Network Reinforcements (UNR) process described in this chapter iteratively calls upon sections of REM to compute the optimal electrification strategy for all of the consumers in the dataset, then it calculates and allocates necessary network reinforcement costs across the set of grid-connected clusters to better inform the ultimate electrification strategy.

The UNR process which has been developed relies on the Greenfield and Brownfield versions of the Reference Network Model (RNM) for its cost calculations and network designs. Greenfield RNM is used to develop a representational base network, while Brownfield RNM is used to compute essential reinforcement requirements needed to maintain system reliability.

5.2 Literature Review of Network Reinforcement Concepts

Before connecting a large load to the existing electrical network, DISCOMs will typically carry out studies to determine the impact of the proposed connection on the overall system by identifying connection limitations and any requirement for upstream reinforcement. In a personal interview with the lead engineer of a U.S.-based utility, the engineer confirmed that when analyzing a new or changed connection, the utility will assess:

1. The capacity along the entire path to serve the connection (i.e. transmission, substation, distribution, service, transformer, service)
2. Voltage (i.e. flicker and steady-state voltage regulation)
3. Stability (i.e. frequency regulation and potentially cascading events)

4. Protection coordination and loss reduction

Field designers of the DISCOM will verify connected loads against the main breaker size, the service voltage, size, and length, and the service transformer. For larger load additions, an engineering team will verify the line, substation, and transmission capacity, as well as any protection and coordination changes or issues. If any items are found deficient, the required system reinforcements are engineered and estimated. Modern utilities may use power flow software to support their assessments.

Several mathematical approaches to optimizing electrical network asset planning with consideration of relevant reinforcement projects have been published. In fact, the concept of considering network reinforcements in generation and network expansion planning is quite common. Generation and network expansion planning problems must decide upon necessary investments, which often includes reinforcements, to meet projected demand while respecting technical and financial constraints. For example, Levi and Calovic propose a methodology for optimal transmission expansion planning and decide on the economically ideal network reinforcements [35]. Soroudi and Ehsan present a dynamic multi-objective model for distribution network expansion which finds the optimal network investments and reinforcements over the planning period [36]. Gutiérrez et. al. describe ANDREA, a long-term dynamic planning tool for sub-transmission electricity networks which considers the reinforcement of existing lines and transformers, new connections between existing substations, and new substation connections to the network [37].

In terms of considering a methodology to allocate the cost of upstream network reinforcements to downstream connected consumers, a fair approach which considers consumer affordability and recovering the full cost of the projects is necessary. Rural electrification is a costly enterprise which is made even more difficult by the limited wealth of the consumers it seeks to connect. Abdelmottaleb, Gómez, and Reneses begin approaching this network cost allocation process by proposing a distribution network cost allocation methodology: The authors utilize either a postage stamp or marginal participation method to allocate distribution network costs to each network user in order to ensure the recovery of the distribution network costs as well as to send efficient short- and long-term signals to all network users reflecting their contribution to network costs [38].

Although these mentioned papers and methods approach the task of calculating and allocating distribution network costs, no state-of-the-art rural electrification planning tool has succeeded yet in considering upstream consequences, due to the task's complexity. To the author's knowledge, this activity's calculation of upstream network reinforcements and its integration within REM is the first of its kind.

5.3 Description of Theory

5.3.1 Absolute and Relative Costs of Energy

To approach the task of calculating necessary network reinforcements because of demand requirements, we define the following absolute annual costs (\$/year) which compose a region's electrification strategy:

- **G** Generation costs
- **H** High-voltage network costs
- **M** Medium-voltage network costs
- **L** Low-voltage network costs
- **P** Any other cost not included in the rest of the items

All of these terms include fixed and variable costs, such as investment, losses, maintenance, and fuel (specific to the generation term).

We define also:

- **E** Total energy consumed by all the network consumers in a year (kWh/year)

Now we define the different relative volumetric charges (in \$/kWh) such that:

$$\bullet g = \frac{G}{E} \quad \bullet h = \frac{H}{E} \quad \bullet m = \frac{M}{E} \quad \bullet l = \frac{L}{E} \quad \bullet p = \frac{P}{E}$$

5.3.2 Current Representation of Network Reinforcements within REM

The cost parameter used in REM for connecting clusters of consumers to the grid is the “grid-energy cost” in MV feeders. This parameter can be stated as a different value for each segment of each MV feeder, although usually a single value is set for the entire MV network. For the sake of simplicity, and knowing that this is the approach followed in the UNR process, we will assume a single value c to represent the grid-energy cost (\$/kWh) for the entire network.

According to the formulation proposed here, these are the facts about the current status of REM:

- REM considers that $c = p + g + h + m$
- REM assumes that all the components of the expression above are constant (i.e. proportional scaling assumption for reinforcements). The value of c is an external constant

input which is intended to represent the above mentioned cost components in the region of interest.

The shortcomings of the current representation of network reinforcements within REM are that 1) the network-specific component within the grid-energy cost (c) is guessed, not calculated, and 2) this cost is represented as \$/kWh number, a value which is weakly connected to the reinforcement costs; reinforcement costs arise predominantly because of increases in system peak power (kW).

Therefore, in the method which I will present in this chapter, I will remove the network-specific component from the grid-energy cost and explicitly consider the cost of upstream network reinforcements as a cost driver within electrification mode decisions. Ultimately my improved method will result in less expensive electrification strategies for the entire system.

5.4 Description of the UNR Process

The architecture of the UNR process is illustrated in Figure 5-1. A case example is provided in Section 5.6 which mirrors the steps of the process. This process, described with respect to the numerical ordering in the figure, is executed for a case as follows:

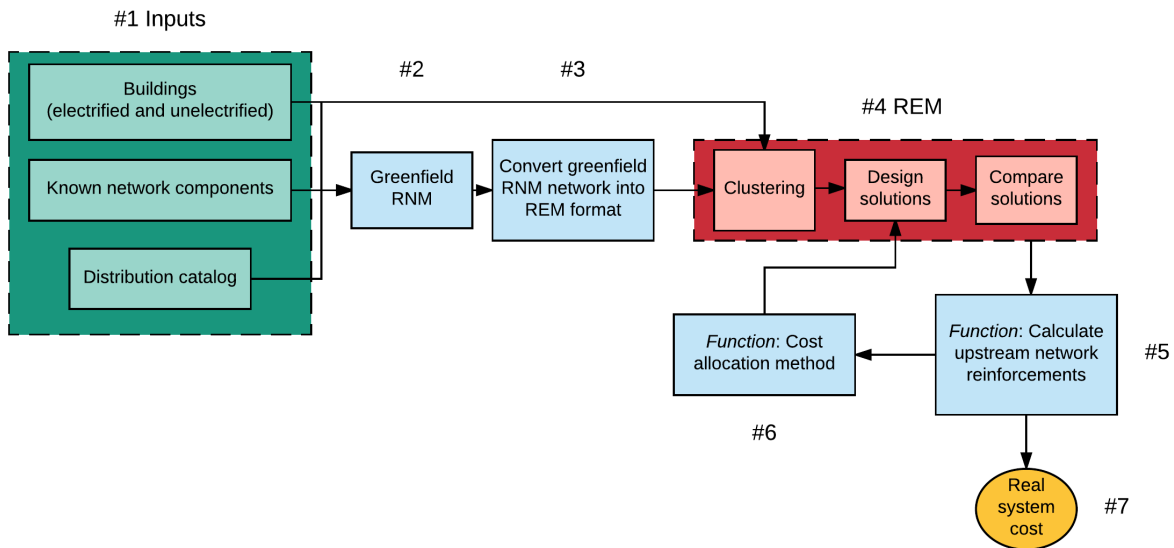

Figure 5-1: Upstream network reinforcements process

1. Collect the input data to be used within the various steps of the process.

- (a) Provide the geographic location and demand of all already electrified buildings as well as the geographic location and anticipated demand of all unelectrified buildings.
 - (b) Provide all known components and configurations of the existing electrical network. At a bare minimum, it is necessary to provide the location and capacity of all grid substations (i.e. transmission substations). However, if any data on the following items is available, it can also be entered to build as accurate a network as possible: Power substations (i.e. HV/MV substations), MV distribution network, HV distribution network, and distribution transformers.
 - (c) And finally, a distribution catalog containing the cost and capacity of all network equipment components (e.g. lines, conductors) must be provided.
2. In order to maintain compatible files for use with Brownfield RNM computations later in the process, run Greenfield RNM for the case to generate a representation of the network which connects the already electrified buildings.
 3. Then, the network layout produced by Greenfield RNM is converted into a format which is readable by REM.
 4. Assume a value of c , the relative cost parameter defined externally to represent the grid-energy cost; the value of c should exclude the costs of the network reinforcements so that the process described in this section can accurately calculate the costs of network reinforcements. Run REM (which consists of Clustering, Design, and Comparison steps) with the location and demand of electrified and unelectrified buildings and the converted network layout. Identify the clusters of consumers for which it is least expensive to connect to the grid instead of to an off-grid solution.
 5. Run Brownfield RNM using as inputs the electrified buildings provided in the input step, the unelectrified buildings which REM determines should be connected to a grid extension, and the layout of the network provided earlier by Greenfield RNM. Brownfield RNM expands the existing network to connect all of the new grid extension buildings to the grid and produces a breakdown of all necessary upstream network reinforcements and their respective costs. The costs produced by Brownfield RNM can be divided into four different categories:
 - (a) *Initial*: The cost of constructing the initial network, which should closely align with the initial network costs produced by Greenfield RNM.
 - (b) *Reinforcement*: The cost of reinforcements needed to make the network feasible, not considering additional demand or distributed generation (this is usually a very low value and is only due to discrepancies with Greenfield RNM or data inconsistencies about the input network if not provided with Greenfield RNM).

- (c) *Incremental*: The cost to construct the network needed to connect the new buildings to the network.¹
 - (d) *Incremental reinforcement*: This is the primary cost of interest. It represents the costs of upstream network reinforcements due to additional demand or distributed generation.
6. Divide the *Incremental reinforcement* cost by the peak power of the grid extension clusters to arrive at \$/kW cost for upstream reinforcements. The cost is then used to account for the distribution network reinforcement cost due to the connection of each grid-extension cluster. Three different cost allocation methods have been proposed, each of which will be discussed in Section 5.5.
 7. Run the Design and Comparison steps of REM again² to redesign the optimal electrification strategy for the original set of clusters, assuming that connecting a cluster to the grid now includes the additional cost of upstream network reinforcements, which was previously not fully considered. Then Brownfield RNM will compute the final upstream network reinforcement costs due to the most recent optimal electrification strategy to be used to inform planning decisions.

5.5 Cost Allocation Methods

Once the cost of upstream network reinforcements has been calculated after an iteration of running REM and then Brownfield RNM, the cost needs to be allocated across the network's grid extension clusters so that the case's electrification strategy can be reevaluated. However, the method of this cost allocation can vary with respect to regional regulatory preferences. In this section, the reasoning behind allocating the reinforcements cost on a \$/kW basis is explained, then three possible cost allocation methods are proposed. Later, in Section 5.6, the first allocation method will be demonstrated in a case example.

5.5.1 Allocating the Cost of Upstream Network Reinforcements on a \$/kW Basis

In the improved method described in Section 5.4, Brownfield RNM was used to calculate the cost of upstream network reinforcements for the system. The computed total cost of

¹The cost to connect new grid extension consumers produced by Brownfield RNM is not similar to the cost to connect new grid extension consumers produced by REM. For now, the connection cost produced by Brownfield RNM is not used, although future efforts should examine the methodology within each model which contributes to the difference in connection costs between the two models.

²The Clustering step of REM is not used in the redesign process because this process seeks to preserve the original clustering decisions and instead reconsider only the electrification mode decisions.

reinforcements is next divided by the peak power of the grid extension clusters to arrive at a \$/kW cost. Then, this cost is allocated to the network’s grid extension clusters with respect to their contribution to the system’s peak power.

This allocation of reinforcement costs is not considered on a volumetric basis (\$/kWh) because volumetric charges are not cost reflective and consumption is a poor proxy for network-related costs. Bharatkumar in [39] notes that “A key driver of distribution network costs is the need to design the network to accommodate peak power flows. Because of system planning requirements to ensure that distribution capacity can meet peak load under a variety of load conditions, the impact of network users’ peak demand is a central consideration in distribution system design.”

Figure 5-2 presents the load profiles of two different clusters intended to demonstrate an example of the allocation of network costs on a volumetric versus capacity charge basis. If two different clusters of consumers were to connect into a section of the existing network with limited capacity, network reinforcements would likely be necessary. Clusters A and B have the same energy consumption--1,280 kWh--over the course of a day. However, the peak power of each cluster differs: Cluster A has a peak power of 125 kW, while Cluster B has a less significant peak power of 75 kW.

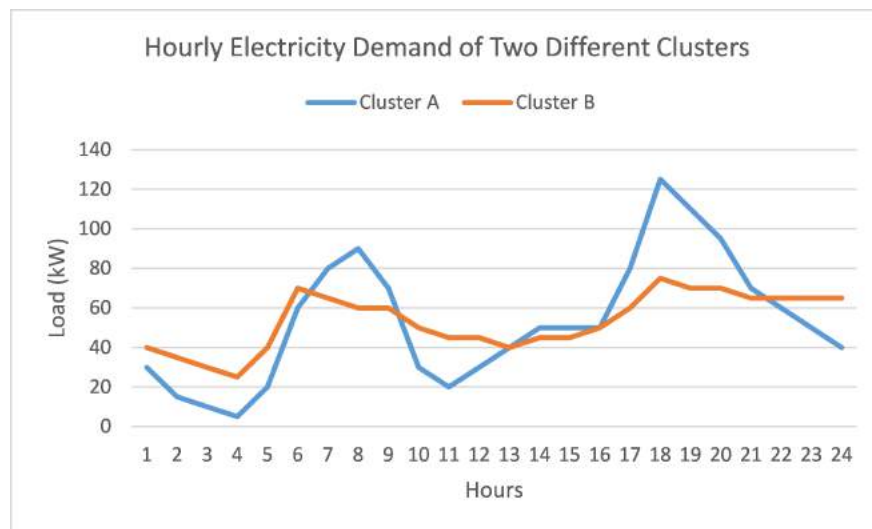

Figure 5-2: Daily load profile of two different clusters of consumers

Under a volumetric charge scenario, both clusters would be equally responsible for any necessary network reinforcements. However, this volumetric cost allocation would not result in efficient electrification designs because Cluster B has a less significant contribution to the peak power of the system than Cluster A. The peak power to energy consumption ratio of Cluster A is 0.098, while the ratio is 0.059 for Cluster B. Therefore, the upstream network reinforcement costs in the UNR process are allocated across network-connected clusters on

the basis of their contribution to peak power.

5.5.2 Method 1: Run Brownfield RNM Simultaneously for All GE Clusters

1. After obtaining the electrification assignment (i.e. GE, MG, or SA) for each cluster of consumers from REM, Brownfield RNM is executed with the already electrified buildings and the new GE buildings as inputs to calculate the cost of network reinforcements.
2. The cost of network reinforcements is divided by the collective peak power of all of the clusters selected for grid extension projects, thereby yielding a specific reinforcement cost in \$/kW. This cost is then allocated across all of grid extension clusters on the basis of their contribution to the system peak power.
3. The Design and Comparison steps of REM are again executed; however, when the GE clusters are evaluated for their electrification mode this time, an additional cost (i.e. the specific \$/kW network reinforcement cost multiplied by the peak power of the cluster) is added to the cost for the cluster to become a grid extension project. The electrification strategy of REM may differ this time from its original electrification strategy because of this additional charge (e.g. some expensive GE clusters may switch to MG or SA mode due to the additional cost which would be added onto GE clusters).
4. Run Brownfield RNM again to calculate a new reinforcements cost for the current electrification strategy.

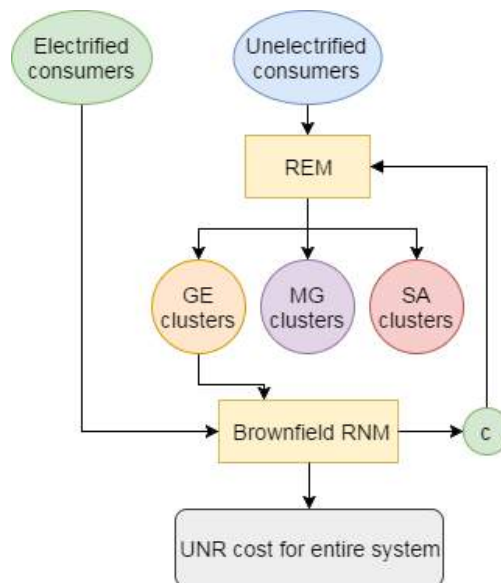

Figure 5-3: Cost Allocation Method 1

Advantages:

- Brownfield RNM is executed in a single pass for the entire network.

Disadvantages:

- By allocating the total reinforcements cost on a uniform per-kW basis to each GE cluster, it is assumed that each GE cluster is responsible in proportion to demand for contributing to the reinforcement costs, regardless of the impacts due to their location in the network. For example, clusters which connect to areas of the network already close to capacity may disproportionately necessitate reinforcement projects in the network.
- It is very difficult to isolate the exact impact which one GE cluster has on the entire grid.

5.5.3 Method 2: Run Brownfield RNM for One GE Cluster at a Time

This second method has not yet been extensively tested, but it seeks to more accurately isolate cluster-specific impacts on the network.

1. After obtaining the electrification assignment (i.e. GE, MG, or SA) for each cluster from REM, run Brownfield RNM for one GE cluster at a time: Each run with Brownfield RNM will contain the same set of electrified buildings but only one new GE cluster, which will be a different GE cluster for each run.
2. A table will be generated from all of these separate Brownfield RNM runs where:
 - (a) Each row represents a single GE cluster, and
 - (b) The columns will represent the ID of the GE cluster, the cost difference (as determined by REM) between the choice for a GE over a MG for the cluster, and the reinforcements cost (as determined by Brownfield RNM) due to the GE cluster connecting to the existing grid.
3. All of the GE clusters in this table will be sorted in order of increasing reinforcement costs. This merit order based on the relative GE advantage (i.e. percentage of savings for selecting the GE mode with respect to the OG mode) could be useful, for example:
 - (a) To prioritize projects, if there's known limited generation or transmission capacity in the region.

- (b) To implement a GE bias (i.e select the GE mode even when the the GE advantage is negative)
 - (c) To detect GE penetration levels that cause discrete jumps in upstream network reinforcement costs.
4. Run Brownfield RNM for all of the clusters which remain in the GE mode to calculate a final upstream network reinforcements cost.

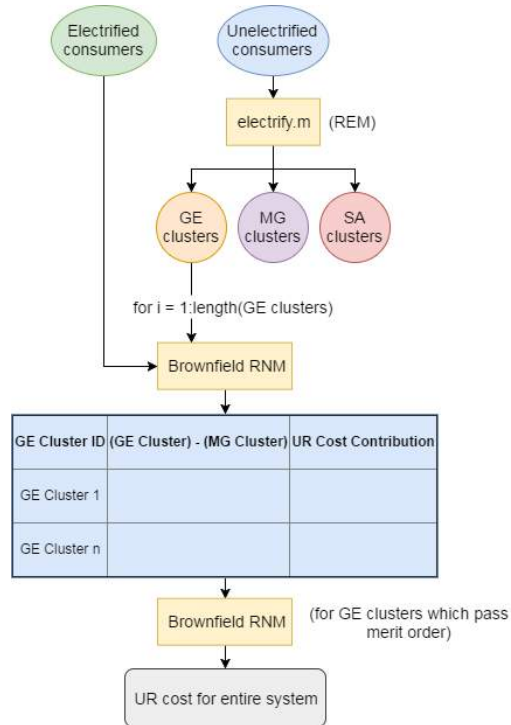

Figure 5-4: Cost Allocation Method 2

Advantages:

- The effect of each cluster on the overall system reinforcements cost can be isolated.

Disadvantages:

- The combined effect of the clusters connecting to the network is not known. An example is provided in Figure 5-5: We assume that the capacity of the substation for the uppermost 11 kV feeder line is 50 kVA and is only currently using 30 kVA. If GE Clusters #1 and #2 each would contribute 15 kVA to the system if they connected, then Method 2 would tell us that it would be fine for both GE Clusters #1 and #2 to

connect and no upgrading of the substation would be required. However, if these two clusters did end up connecting to the grid, their substation would need to be upgraded and other possible reinforcements could be necessary.

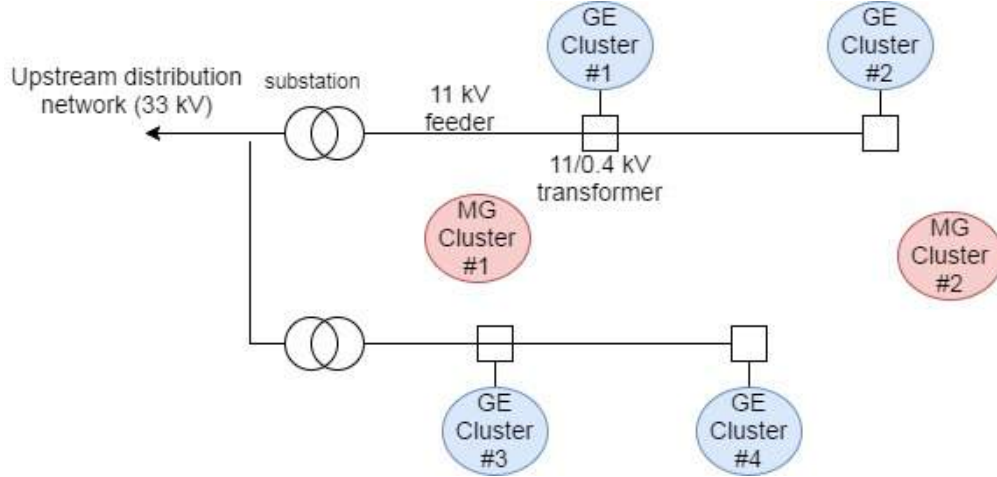

Figure 5-5: Example network for Cost Allocation Method 2

5.5.4 Method 3: Combination of Methods 1 and 2

This third method is currently untested, but it seeks to more accurately isolate cluster-specific impacts on the network and more fairly allocate reinforcement costs across the consumers of the network.

1. Applying Method 1 to the case would compute a total reinforcement cost for all of the grid-connected consumers at once, or URC_{Total} .
2. Applying Method 2 to the case would compute a reinforcement cost specific to each individual cluster. An individual cluster's impact on the network with respect to the aggregated impact due to all of the clusters could be represented by a "participation factor":

$$PF_i = \frac{URC_i}{\sum URC_i}$$

3. Ideally the two system-level impact representations, URC_{Total} and $\sum URC_i$, should be equivalent. However, if the two vary, perhaps an individual cluster's responsibility for network reinforcement costs could be represented by a Cluster Responsibility variable:

$$CR_i = PF_i * URC_{Total}$$

5.6 Case Study of the Kayonza Region of Rwanda using Cost Allocation Method 1

Section 2.5 was focused on demonstrating the application of Regional REM to the region of Kayonza in Rwanda. This section will again use the case study of Kayonza and all of its input data (e.g. building locations, layout of existing network, discount rates) and results to illustrate the calculation of upstream network reinforcements and the general improvement which this method can provide over its current representation in REM. This section is organized to follow the UNR process described in Section 5.4 using Cost Allocation Method 1.

Step 1: Collect Input Data

The known electrified and unelectrified buildings are plotted in Figure 5-6a: There are 8,777 buildings which are already connected to the grid and 40,816 buildings which are unconnected. The demand profiles and building types of each of the buildings have been imported from the previous case study in Section 2.5. The peak load consumed by the already electrified buildings is 862 kW. The existing MV network in the region is plotted in Figure 5-6b.

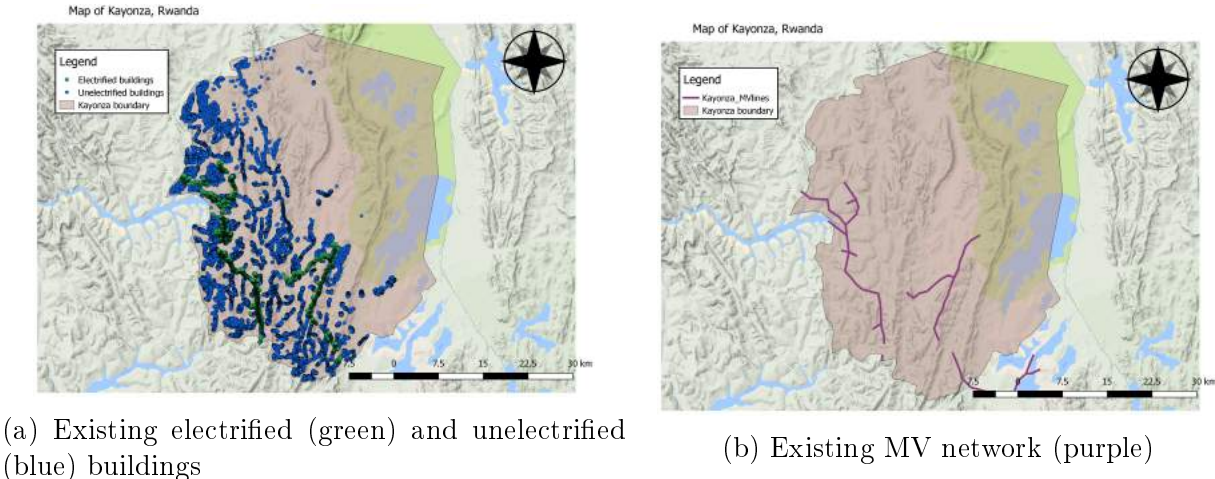

Figure 5-6: Available input data for Kayonza

Step 2: Run Greenfield RNM to Build Network

Running Brownfield RNM later in this process will require a complete representation of the network, including the LV network. In this case, only information on the layout of the MV

network is available. Therefore, Greenfield RNM is executed³ with the MV network, the location of the electrified buildings, and a distribution catalog as inputs.⁴ Greenfield RNM produces the complete representation of the network which is required by Brownfield RNM.

The layout of the network produced by Greenfield RNM to connect all of the already electrified buildings is shown in Figure 5-7.⁵ Table 5.1 lists the necessary network costs and components of the design, while Table 5.2 lists the costs and components of the necessary distribution transformers and substations. Note that some of the less significant components produced by Greenfield RNM (e.g. protection equipment) are not explicitly listed in either of these tables, but they are taken into account in the process.

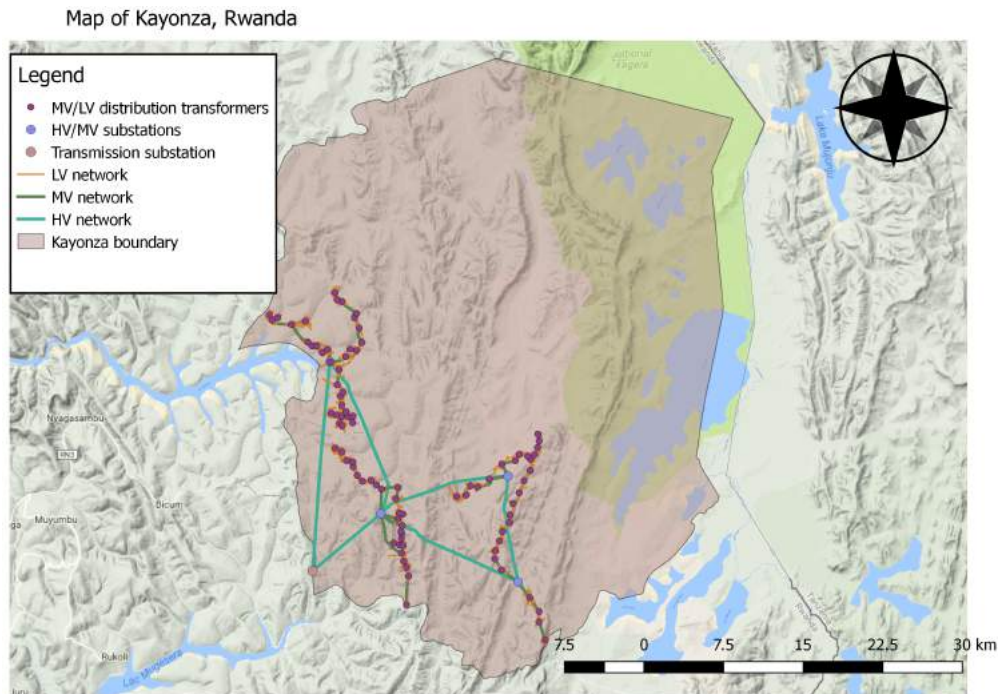

Figure 5-7: Greenfield network layout generated by Greenfield RNM

³The process described in this section uses Greenfield RNM executable file *E-GRID_Greenfield_20161207b_ENG.exe*.

⁴Providing the existing MV network as an input to Greenfield RNM will constrain the model to building a network with MV segments where the existing MV segments are located, but the model may add new HV, MV, or LV segments to properly connect all of the building locations also provided as an input.

⁵Greenfield RNM produces 39 km of underground MV lines because the design logic of the model was developed to represent practices in Spanish utilities. Currently members of the Universal Access Lab are considering conducting a validation process which would likely result in a new version of RNM to represent the practice of distribution companies in Rwanda and other countries where rural electrification is a pressing issue.

	Length (km)		Investment Cost (USD)
	Aerial	Underground	
LV network	325.55	0	548,674
MV network	104.46	39.19	959,159
HV network	78.03	0	434,082
Total	508.05	39.19	1,941,915

Table 5.1: Greenfield network specifications generated by Greenfield RNM

	Number	Investment Cost (USD)
MV/LV distribution transformers	49	131,520
HV/MV substations	3	140,860

Table 5.2: Transformer and substation specifications generated by Greenfield RNM

. The outputs from Greenfield RNM would be:

- $H_i = \$574,942$ Absolute initial cost of HV network⁶
- $M_i = \$1,090,679$ Absolute initial cost of MV network⁷
- $L_i = \$548,674$ Absolute initial cost of LV network

Step 3: Convert Greenfield RNM Network into REM-formatted Network

Greenfield RNM will produce a file containing the network's topology in a format which describes a single section at a time. In the below example of a network topology produced by Greenfield RNM with two sections, the first section consists of four vertices and the second section consists of two vertices.

This network format must be converted into a format readable by REM; the format required by REM is described in *Appendix A*.

⁶The investment cost of HV/MV substations is included within the investment cost of the HV network.

⁷The investment cost of MV/LV distribution transformers is included within the investment cost of the MV network.

Section 1
x1, y1, z1
x2, y2, z2
x3, y3, z3
x4, y4, z4
END
Section 2
x1, y1, z1
x2, y2, z2
END
END

Table 5.3: Example network topology produced by Greenfield RNM

Step 4: Run REM for the Case to Determine Initial Electrification Strategies

In the first application of REM demonstrated in Kayonza in Section 2.5, the value of c , or the grid-energy cost in each MV feeder, was assumed to be \$0.20/kWh. However, in this first run of REM in the UNR process, the value of c is set to \$0.15/kWh to represent the grid-energy cost without considering any network-specific components. This assumption that network components constitute approximately 25% of the grid-energy cost is derived from the MIT Energy Initiative’s *Utility of the Future* report, which separated the components of electricity bills from multiple regions around the world (see Figure 5-8).

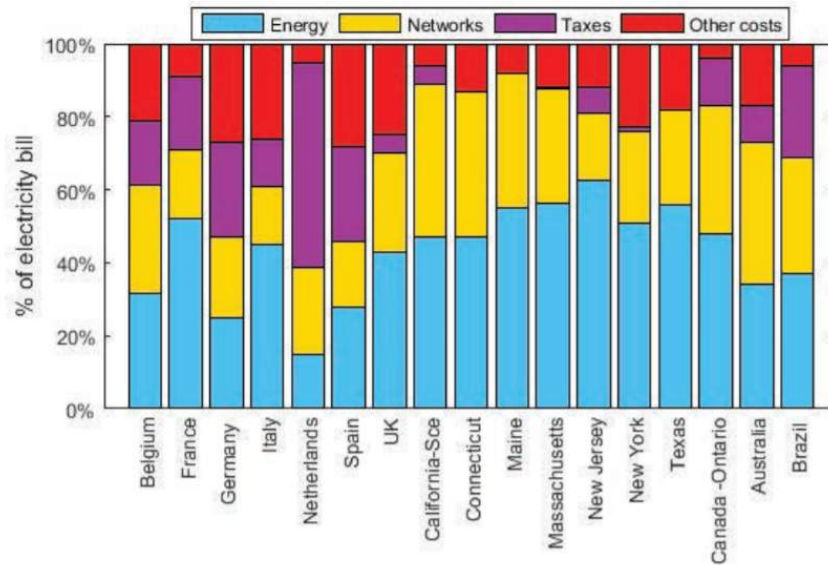

Figure 5-8: Breakdown of residential electricity bills in different jurisdictions in 2014-2015. Reprinted from [40].

Of the 40,816 unelectrified buildings, REM grouped 39,645 buildings into 70 different grid extension clusters and 1,107 buildings into 48 microgrid clusters, and the remaining 64 buildings were designated to be standalone systems. The ultimate annuity of the entire electrification system was computed to be \$3,552,485, while the peak power consumed by the new grid extension buildings is 3,866 kW. Figure 5-9 displays the distribution of grid extension, microgrid, and already electrified consumers with respect to the location of the network.

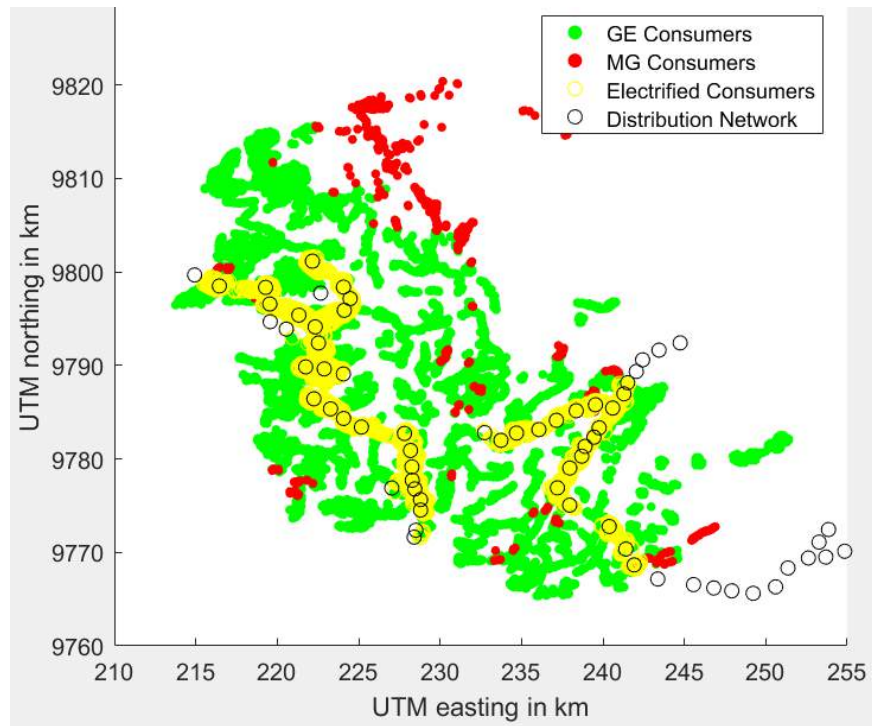

Figure 5-9: Minimum cost electrification strategy produced by REM for Kayonza

Step 5: Run Brownfield RNM to Calculate Upstream Network Reinforcements

Brownfield RNM is executed⁸ using the network produced earlier by Greenfield RNM, the location of the already electrified buildings as well as the new grid extension buildings, and a distribution catalog as inputs.

The electrical infrastructure needed to connect all of the new grid extension buildings as well as to reinforce the existing network due to the new load additions is shown in Figure 5-10. Table 5.4 lists the network costs and components necessary to reinforce the grid.⁹ Table 5.5

⁸The process described in this section uses Brownfield RNM executable file *E-GRID_Brownfieldx64_20170505.exe*.

⁹There are network investment costs without any new planned lines in Table 5.4 due to the cost of losses

lists the costs and components of the necessary substation and distribution transformers for reinforcing the network. Note that some of the less significant components produced by Brownfield RNM (e.g. protection equipment) are not listed in either of these tables, but they are taken into account in the process.

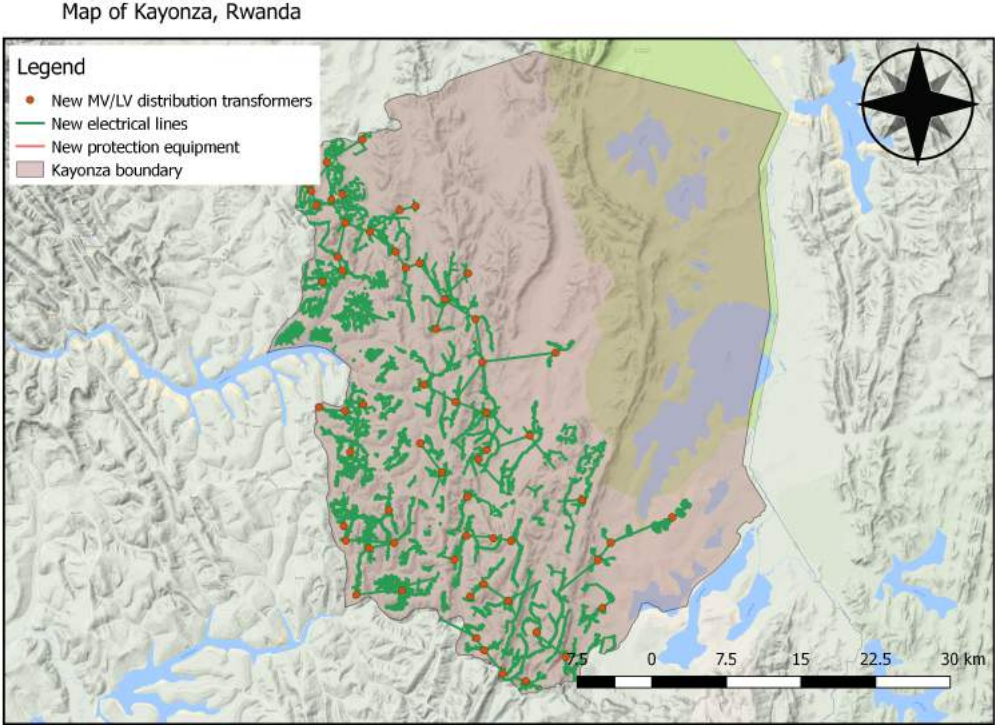

Figure 5-10: Brownfield network layout generated by Brownfield RNM

	Length (km)		Investment Cost (USD)
	Aerial	Underground	
LV network	0.33	0	292,984
MV network	0	0	179,901
HV network	0	0	82,285
Total	0	0	555,170

Table 5.4: Brownfield network specifications generated by Brownfield RNM

	Number	Investment Cost (USD)
MV/LV distribution transformers	20	577,878
HV/MV substations	0	3,777

Table 5.5: Transformer and substation specifications generated by Brownfield RNM

The outputs from Brownfield RNM would be:

which occur in the sections of the network. No new lines are necessary to reinforce the network primarily because of the low level of demand from the network’s consumers.

- $H_d = \$86,062$ Absolute incremental cost of HV network¹⁰
- $M_d = \$757,779$ Absolute incremental cost of MV network¹¹
- $L_d = \$292,984$ Absolute incremental cost of LV network

Step 6: Calculate and Allocate the Costs of Upstream Network Reinforcements

The peak power of the new grid extension buildings from REM is 3,866 kW, while the cost for upstream network reinforcements was computed by Brownfield RNM to be \$1,136,900. Therefore the cost-to-be-allocated due to network reinforcements is \$294.07/kW.

As defined in the description of Cost Allocation Method 1, this charge will be allocated across all of the grid-connected clusters in the reevaluation phase using REM.

Step 7: Run Design and Comparison Steps of REM, then Brownfield RNM, Again for the Case

The upstream reinforcement cost on a \$/kW basis is introduced into REM. This value is introduced into REM after the Clustering step of the process so that the original clustering designs are preserved, but the on-grid versus off-grid decision for each cluster may change.

The updated REM case preserved the same electrification mode for all of the buildings as in the previous REM case. Of the 40,816 unelectrified buildings, REM grouped 39,645 buildings into 70 different grid extension clusters and 1,107 buildings into 48 microgrid clusters, and the remaining 64 buildings were designated to be standalone systems. However, the ultimate annuity of the entire electrification system was computed to be \$3,608,400, a higher cost than the previous REM case because of the additional reinforcements cost. The peak power consumed by the new grid extension buildings also remains at 3,866 kW. Figure 5-9 displays the distribution of grid extension, microgrid, and already electrified consumers with respect to the location of the network.

¹⁰The investment cost of HV/MV substations is included within the investment cost of the HV network.

¹¹The investment cost of MV/LV distribution transformers is included within the investment cost of the MV network.

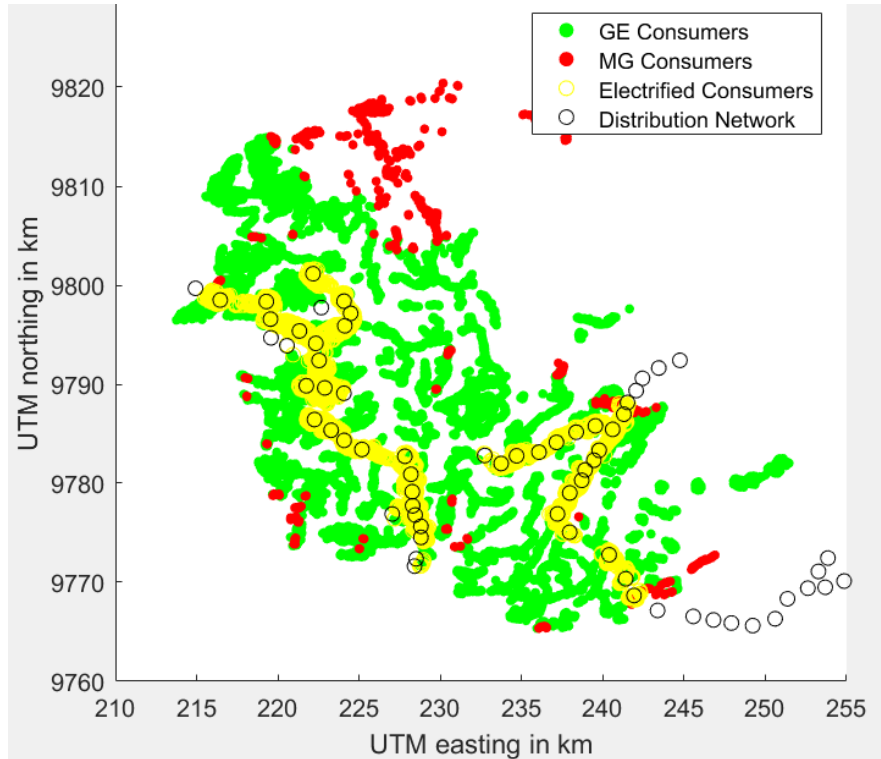

Figure 5-11: Updated minimum cost electrification strategy produced by REM for Kayonza

The outputs from Brownfield RNM for the revised REM case are similar to the earlier Brownfield RNM run because the electrification strategy has only slightly changed:

- $H_d = \$86,291$ Absolute incremental cost of HV network¹²
- $M_d = \$758,624$ Absolute incremental cost of MV network¹³
- $L_d = \$301,623$ Absolute incremental cost of LV network

The combined peak power of the new grid extension buildings from the revised REM run is 3,866 kW, while the new cost for upstream network reinforcements is computed by Brownfield RNM to be \$1,146,600. Therefore the cost-to-be-allocated due to network reinforcements for any subsequent REM cases would be \$296.58/kW.

5.7 Conclusions and Implications

The case study presented in Section 5.6 relied on a series of assumptions. Table 2.2 in Section 2.5 presents several of the parameters (e.g. discount rate, network lifetime) which

¹²The investment cost of HV/MV substations is included within the investment cost of the HV network.

¹³The investment cost of MV/LV distribution transformers is included within the investment cost of the MV network.

were used. Additionally, the case study assumed that network-related components constitute 25% of a grid-energy cost set at \$0.20/kWh. Modifying any of these input parameters could result in an different result. For example, assuming that the network should be a larger consideration within the grid-energy cost could allow the cost of upstream network reinforcements to have a greater influence on the final electrification solution.

However, the presented case study is able to provide valuable and generalizable conclusions. Cost Allocation Method 1 applied to the case study has shown that more accurately representing the network-related component of the grid-energy cost within REM can result in improved and less expensive electrification strategies, as expected. Table 5.6 summarizes the results of the “normal” REM case in Section 2.5 and the revised REM case which explicitly considers upstream network reinforcements in Step 7 of Section 5.6. Note that in comparison to the “normal” case of REM in Section 2.5, the revised REM case demonstrated in Step 7 of Section 5.6 presents more consumers connected to the grid, fewer consumers connected to microgrids, reduced overall system costs, and an explicitly calculated cost of upstream network reinforcements. Although the UNR process presents improvements to the current representation of network reinforcements within REM, the similarity between the two cases suggests that the initial estimation of the fraction of the grid-energy cost (c) corresponding to network-related reinforcements needed (i.e. 25%) is close to the actual value, as computed by Brownfield RNM.

Parameter	Normal REM Case	Updated REM Case with UNR
Grid-energy cost (\$/kWh)	0.20	0.15
UNR charge (\$/kW)	N/A	294.07
No. GE Connections	39,609	39,645
No. MG Connections	1,143	1,107
No. SA Connections	64	64
Total Annuity (\$)	3,887,996	3,608,400

Table 5.6: Summary of REM case studies in Kayonza

Between the two REM cases within the UNR process of Section 5.6, the final electrification mode of the buildings did not change and the total electrification cost increased only slightly in the second case. These trends suggest that the power/energy ratio of the grid extension clusters in the case study is similar across all of the grid extension clusters. This similarity is reasonable because the clusters include a significant number of buildings, and even though 10 types of load profiles are used in the case study, most of the buildings have either small residential or large residential load profiles. Load diversity can be significantly larger in real settings, in which case the application of this UNR process would have a greater effect on reevaluating the electrification mode of each cluster.

This chapter has demonstrated that the calculation of upstream network implications can be included within the workflow of a case which utilizes REM. However, continued work

in this space could further improve the method and its ramifications on system design. Some examples of continued work in this area could include:

1. Cost Allocation Method 2 can isolate the contribution to network reinforcements of a single cluster to the system, but the decision as to when to reject a particular cluster from connecting to a grid extension project has not yet been made. Additionally, Cost Allocation Method 3 has yet to be rigorously tested with REM.
2. Because Brownfield RNM was originally developed to compute efficient remuneration costs for Spanish utilities, the model had to be modified over many iterations in order to converge upon a form which could handle attributes specific to rural electrification efforts. Testing should be done to better understand the methodology and cost calculations between Greenfield RNM, Brownfield RNM, and REM.
3. Depending on the magnitude of a new connection, there could be upstream implications beyond the distribution level (i.e. reinforcements at the transmission or generation level). Transmission and generation expansion planning models could be connected to this UNR process to holistically consider system improvements.

The UNR process which has been developed then explained in this chapter explicitly incorporates upstream implications, factors which are not typically considered by project developers, into the design of electrification strategies. Upstream implications should be considered for every rural electrification project, whether it be an off-grid or grid extension project, because they can significantly affect the project's viability. Upstream implications should be a general concern in the rural electrification space because system reliability of the network should not be sacrificed simply to accommodate new demand. System planners should more accurately represent the cost of new network connection and reinforcement costs within the overall grid-energy cost. Planners in areas where upstream network reinforcements could affect optimal electrification strategies should take care to properly represent each energy cost precisely.

Chapter 6

Discussion and Conclusions

To alleviate poverty and improve the quality of life of more than a billion global consumers without any access to energy, energy systems must be carefully planned and developed to simultaneously meet affordability, reliability, and demand objectives. Within only the last few decades, many off-grid energy systems have been developed and deployed which do not rely on centralized power generation or transmission, and therefore can overcome many of the common barriers to energy access. For instance, high performance, low cost photovoltaic systems and efficient end-use appliances (e.g. DC televisions which consume only a few watts) increasingly allow consumers access to electricity in resource-constrained areas.

Consumers without access to electricity typically use kerosene or other similar fuels, which contribute to a myriad of issues, for lighting and cooking purposes. Furthermore, the global poor spend a higher fraction of their income on energy services than consumers with established energy distribution infrastructure. Therefore, it is paramount that affordable and reliable connections to an energy supply, either through off-grid or grid extension means, be provided as rapidly as possible to all consumers. Even if the deployed energy system cannot immediately provide the full requirements of modern energy access to all of its consumers, the first few watts of power have a very high value to a consumer because its efficient end-use will lead to high marginal benefits in health, education, and improved quality of life. Between 0.2 and 1 Wh/day provides cell phone charging and costs less than fee-based charging by a factor of 10, while the first 100 lumen-hours of light eliminates kerosene lighting from household and improves household health and safety [41]. Furthermore, Bellanca, Bloomfield, and Rai attest that providing reliable and affordable electricity must be contained within a sustainable business model which is well-developed and appropriate for its environment:

"Increasing access to energy is not only about transferring a range of appropriate technologies and services, but also about understanding their ongoing management and maintenance, as well as ensuring the needs of the end consumers are

met sustainably. Energy delivery models need to be replicable and scalable if they are to result in a broader development benefit beyond the pilot or experimental stage . . . The principal and fundamental aspects that determine the success of any energy delivery model is how suitable and compatible the energy solution is to the community as a whole or to individual end users. Analysis of a wide range of energy delivery models from around the world has led to the identification of five key factors which are believed to be pivotal in shaping the successful delivery of energy products and services: social, environmental, technological, financial, economic, and environmental." [42]

6.1 Utility of REM to its Stakeholders

Computational procedures to design optimal electrification solutions in rural and developing areas of the world offer significant advantages over traditional and less robust techniques. REM, in combination with the improved methods described in Chapters 4 and 5, can efficiently provide energy access to all of the consumers in a region, design the optimal network and electrification strategy to reach the set of consumers, and produce the financial and technical projections for a system planner or policymaker to implement the plan. This comprehensive approach to evaluating the optimal on- and off-grid strategies to provide extensive energy access would be valuable for a number of entities.

Once fully developed, REM as a planning tool can provide value for¹:

- Government agencies (e.g. Ministry of Power or Ministry of New and Renewable Energy) to design optimal subsidies for rural electrification planning.
- Distribution companies (e.g. North Bihar Power Distribution Company Limited) to map out optimal locations for grid extension versus off-grid projects.
- Microgrid developers (e.g. TARAurja) to identify attractive areas for infrastructure investment.
- NGO's (e.g. Prayas) to target areas of highest need.

Additionally, REM is valuable for these stakeholders because of its ability to be used for **sensitivity analyses** and supporting a **grid compatibility standard**.

6.1.1 Sensitivity Analysis

Perhaps one of the largest benefits which REM (either the regional or local version) can provide to its stakeholders is the ability to develop a series of scenarios which project the

¹Note that each of the listed examples of stakeholders are based in India.

impact of modifying certain input variables. A sensitivity analysis, which can be used to determine how changes in the value of an input will impact the outcome of a scenario, is important in the discussion surrounding energy access efforts. Policymakers can ask questions like “If the price of diesel increased by 10%, or if the overall demand for electricity increased twofold, how would the final technical and financial design change?”

For example, Figure 6-1 represents three separate cases of REM applied to the Vaishali region of India. In Figure 6-1a, the model takes the poor reliability of the existing network into account and recommends that all unelectrified buildings be connected to microgrids. However, in Figure 6-1b, the user specifies that the grid has improved to be able to provide reliable electricity service, and now REM proposes that all of the buildings should be connected to grid extension projects. And finally, in Figure 6-1c, the price of diesel is increased significantly from the value first used in Figure 6-1a, and the model proposes a hybrid combination of on-grid and off-grid solutions throughout the region because of the prohibitively expensive cost of diesel. These cases are intended to demonstrate the potential advantage of being able to consider the effect of different input parameters on the final solution.

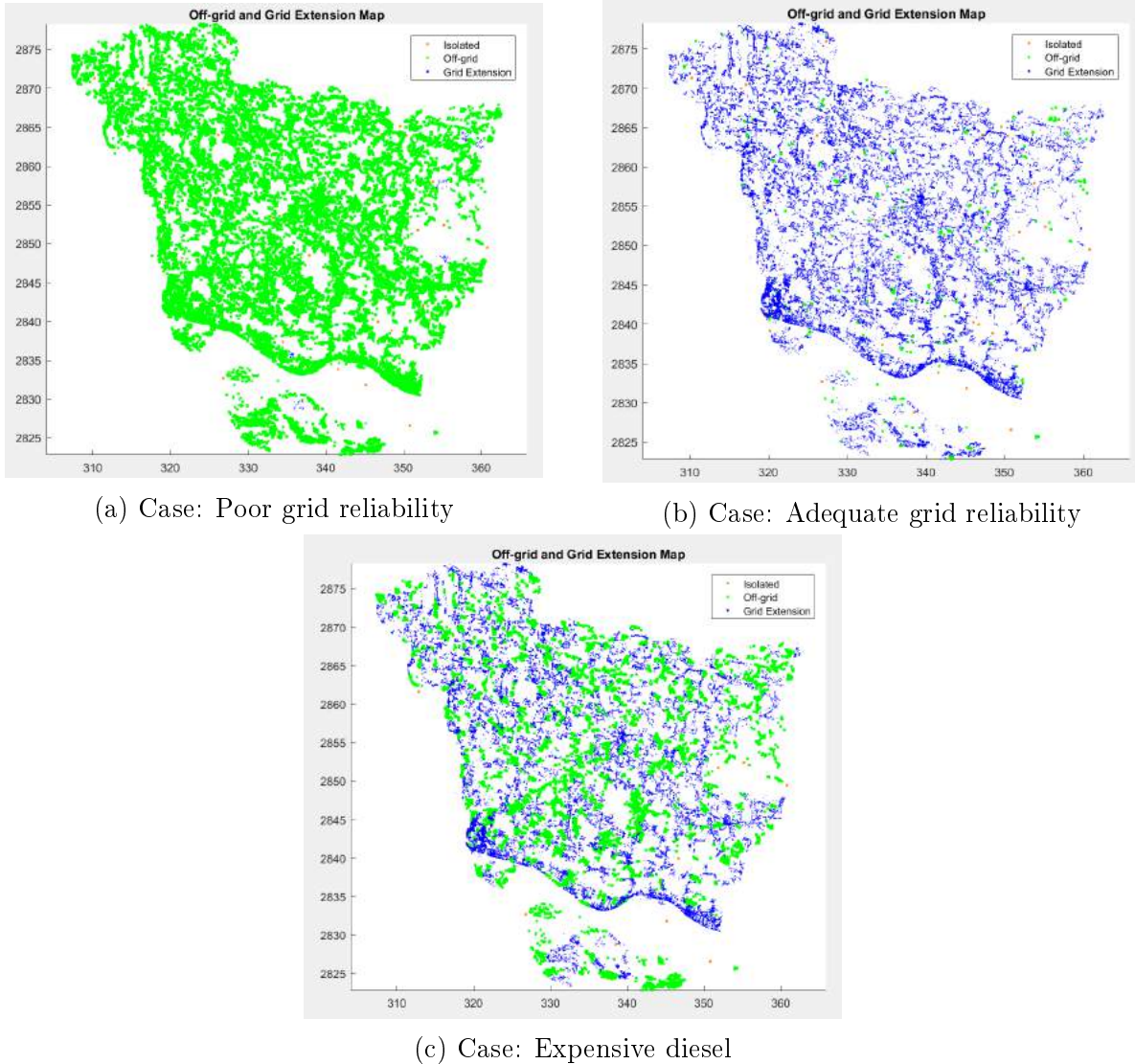

Figure 6-1: Sensitivity case examples produced by REM of the Vaishali region of India

From a renewable energy advocacy standpoint, the consequences of clean energy policies could be examined by comparing the costs of solutions in which fossil fuel resources (i.e. diesel generators) are allowed in the solution set versus the costs of solutions which exclude fossil fuel technologies.

Additionally, the possible advantages or disadvantages of electrification policies can be revealed by adjusting input parameters and viewing the results of the model. By modifying various assumptions and input conditions, users of REM can converge upon a best overall strategy given their respective priorities and constraints. If, however, a DISCOM insists on exclusively extending the grid to the unelectrified consumers in its region, REM can model that decision and project the final cost to see if the DISCOM can finance the cost. If it can't, then perhaps the DISCOM would allow private capital to come in and construct some

microgrids, and then the deficit (i.e. the actual cost of a microgrid’s infrastructure minus the affordability of its consumers) to be covered by the DISCOM, the state, or some external donor would be much smaller.

6.1.2 Grid Compatibility Standard for Microgrids

Many entrepreneurs and project developers are hesitant to seriously pursue microgrid development as a strategy to address energy access needs because of the uncertainty and risk involved with the potential arrival of a grid extension project by the local DISCOM. Governments typically view grid extension projects as the only serious means of connecting their populations, and thereby discount the value of microgrids in the overall solution landscape. Although microgrids can offer a reliable and robust source of power for communities when properly built, the microgrid business model is not typically sustainable in many countries if it must compete with a connection to the existing grid without a supportive regulatory framework.

If microgrids were built to be “grid compatible,” then technically their distribution network could interconnect them with the existing grid’s, if and when a grid extension project was built to connect the microgrid’s community; the microgrid’s generation assets could then feed their power back into the grid, operating like a distributed energy resource (DER). Although an official grid compatibility standard has not yet been published in most of the countries where the interaction between on- and off-grid technologies is a concern, building a microgrid to be grid compatible includes a premium cost. For example, the microgrid’s infrastructure should include two-way inverters, devices which aren’t necessary in independent microgrids, to be able to feed power back into the grid. However, these additional costs are necessary to avoid the possibility of wasted investment if the microgrid’s infrastructure is overhauled by a new network to accommodate the grid. Greacen, Engel, Quetchenbach speak to several of the challenges for a microgrid operator to connect their system to the grid:

“Connection of distributed electric production resources with the grid brings with it a number of technical challenges, for both the mini-grid operator and the national or regional utility. The mini-grid generator must be able to connect safely to the grid at the correct frequency and phase, inject electricity of sufficient quality to meet utility requirements, disconnect quickly and safely from the grid when a disturbance is detected, and reconnect (either automatically or with operator intervention) when it is safe to do so. Challenges for both the utility and the mini-grid operator include maintaining frequency and voltage regulation and coordinating the operation of protective relays and reclosers. Integration of an existing village power distribution system with utility assets will require confor-

mance with utility standards, which may include safety distances and protection corridors. If the existing lines cannot be upgraded to meet utility standards, construction of new medium- and low-voltage distribution lines may also be needed.” [43]

To mitigate this risk of uncertainty for microgrid investors, 1) regulators should produce a grid compatibility standard describing the specifications for how microgrids should be built to accommodate the eventual arrival of the grid, and 2) DISCOMs should publish their plans and associated timing for electrification efforts. To the first point, IEEE has produced several technical standards for grid compatible infrastructure which can be used as a starting point for the development of a comprehensive policy. And to the second point, REM can be used as a tool by DISCOMs to identify the least-cost areas to provide an extension of the grid versus allowing the development of off-grid systems. The publication of grid-extension plans and a clear policy for the future of microgrids when the grid arrives would help reduce the risk of uncertainty for investors. Sri Lanka and Cambodia are positive illustrative examples of the interaction between the grid and off-grid systems.²

The interaction between these two types of technologies is complicated further by cases in countries like India, where microgrids are being set up where the grid already exists, not where it will be extended to later, because the reliability of the grid is so poor. Developing regulations and policies to allow microgrids and other DERs to feed power back into the grid would help to alleviate some of the uncertainty surrounding the reliability of the grid.

6.2 Future Work on REM

REM is nearing a stage of completion for which it will be able to be utilized by any of the stakeholders mentioned in the initial section of this chapter. However, development of the model, both from a technical as well as policy perspective, will still continue after its first deployment as rural electrification needs continue to evolve. I have listed below several areas in the model which I believe should be developed further to accommodate evolving needs:

1. Additional generation resources, other than simply solar, battery, and diesel generator technologies, should be incorporated into microgrid designs. In particular, local resources which a community could utilize (e.g. wind power, hydropower, biomass) should be considered.
2. REM generally considers standalone systems as one means of providing energy access to consumers. However, the advantage of solar home kits needs to be explicitly included

²In this case, the off-grid systems are independent diesel generators.

in the generation catalog of the model because of the widespread popularity of these affordable systems.

3. Chapter 5 describes upstream network reinforcements applied at the distribution level. Generation and transmission expansion models should be joined with the current upstream network reinforcement process to comprehensively consider the large-scale implications of significant rural electrification efforts.
4. It is not yet well understood how demand will change on an individual- or community-level basis once connected to a supply of electricity. The implications of demand growth could significantly affect the design of the electrification solution, although changed demand levels could still be modeled with the current state of REM. For example, generation assets will be undersized if demand unexpectedly increases by twofold over just a few years. Studies in this area are necessary to better inform the value of input data for demand.

6.3 Final Thoughts

6.3.1 Solar Home Kits

Additional attention should be paid to solar home kits as a technology solution to the energy access situation. These systems are developing as a niche solution because they are affordable and portable, can be recharged via a solar panel (DC) or a grid-connected outlet (AC), and wouldn't be rendered obsolete by the arrival of the grid to an area. For example, Schneider Electric's Solar Home System S01 includes a portable 19.2 Wh battery, a 6 W solar panel, and 4 lights which can produce over 500 lumens--all at a price point (<\$100) which is affordable for many consumers in developing countries. They are additionally attractive because they operate as plug-and-play devices (i.e. consumers can open the package and immediately begin using the devices without complex setup steps).

There is an enormous and ever-increasing demand for small-scale solar products in rural and developing areas. To illustrate this point, Figure 6-2 displays the cumulative sales of solar home systems in Sub-Saharan Africa. Figure 6-3 demonstrates that the costs for these systems are continuing to come down, making small-scale solar products an even more attractive technology.

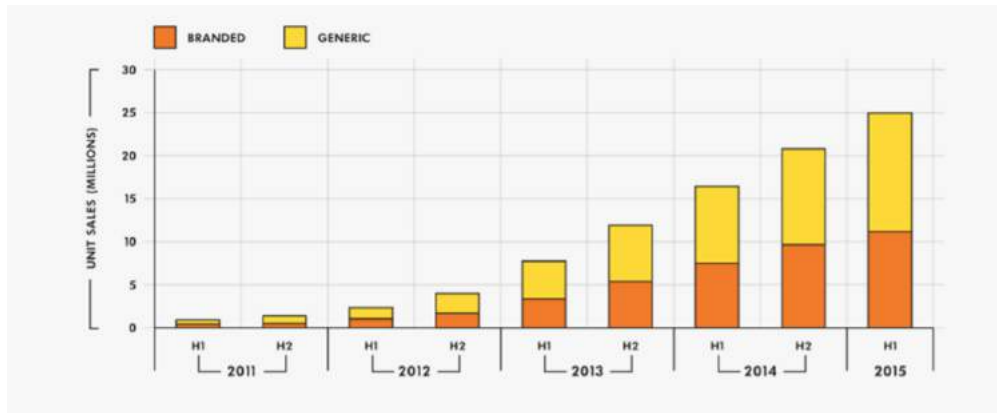

Figure 6-2: Estimated cumulative sales of small-scale lighting products in Sub-Saharan Africa. Reprinted from [44].

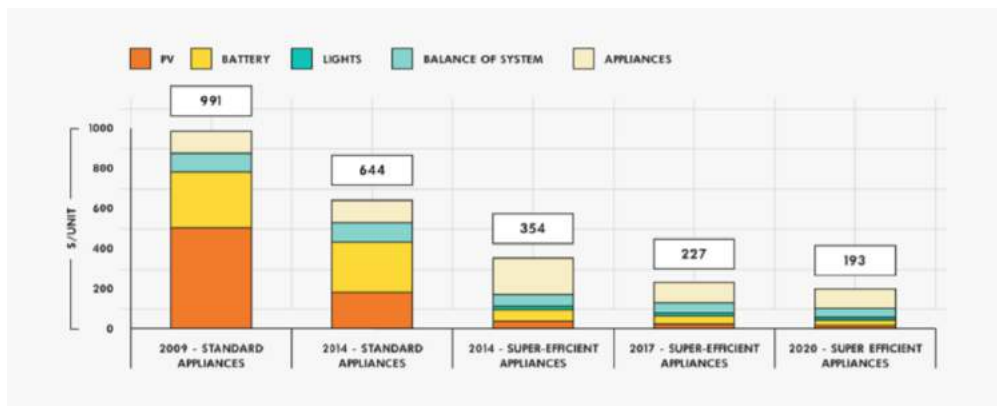

Figure 6-3: Cost trends of solar home systems in Sub-Saharan Africa with 19" TV, radio, and two lights (USD/unit). Reprinted from [44].

For communities in rural areas with low levels of demand and limited finances, these systems can be the simplest and least-cost solution. Solar products can serve as an energy ladder, where as demand increases, additional solar and battery units can be added in a modular fashion; this approach operates in direct contrast to microgrids, which require demand and affordability surveying of the community prior to construction, and risk the possibility of being replaced by the grid eventually. Solar home products should be considered within REM and the general rural electrification solution landscape to a greater extent.

6.3.2 Leapfrogging and Climate Change

Leapfrogging is a term used to describe the implementation of new technologies to bypass the technological stages which other groups have typically gone through. In the context of rural electrification, the developing nations of the world have the opportunity to leapfrog past the

industrialization era and the focus on centralized generation, transmission, and distribution systems because of their lack of pre-existing infrastructure. Instead of focusing on developing centralized systems for which fossil fuel utilization is most common, the countries without pre-existing infrastructure should leverage their resources into developing reliable decentralized systems (e.g. microgrids). This leapfrogging situation can promote the deployment of renewable energy solutions (e.g. DERs) that do not require large-scale networks.

Expanding energy access via decentralized systems could have significant climate and equity impacts if not properly planned. Anthropogenic climate change is predicted to most severely impact the developing world's communities who are less resilient, even though these communities have contributed little to the climate change problem. Providing traditional energy access (i.e. connection to a fossil fuel-based centralized grid) to the entirety of the world's unelectrified population would only marginally increase global emissions because of anticipated low levels of demand. However, the danger is in the longterm effects of providing access in this way: Eventually the newly connected consumers will desire additional appliances and a level of electricity usage mirroring that of average consumers in the developed world, which could have serious implications on the climate.

In terms of climate change mitigation, the most vital contribution which REM can provide is the ability to evaluate long-term approaches to rural electrification and avoid dead ends with negative implications for the global climate system. The result of using REM to design rural energy access is the development of grid-compatible microgrids that do not become obsolete once the grid is finally extended, and the incorporation of renewable energy resources (e.g. PV panels, biomass generators) into microgrids that do not emit the harmful greenhouse gases associated with fossil fuel resources. In addition, because of black carbon, transitioning from kerosene lighting to a non-fossil fuel-based energy connection is ten times better for climate implications, which represents a powerful mitigation opportunity [41].

However, the choice between renewable energy technologies and traditional fossil fuel systems is not always clear-cut for developing countries. For example, India as a nation has low levels of energy access, a developing economy, and large reserves of coal. Why should it not be allowed to develop by using its available fossil fuel resources, as the industrialized nations have? This challenge is complex, particularly since the developing countries were not significant contributors to current climate situation. But the situation now affects us all, regardless of which nations were the initial instigators. Because of the advancing consequences of climate change, it is incredibly necessary for all nations of the world to pursue progressive energy efficiency and renewable energy deployment measures. And for rural electrification activities, this global urgency requires that systems are carefully planned to avoid dead ends and to make use of renewable energy technologies.

Bibliography

- [1] International Energy Agency. Energy Access Database, 2016. Available online at <http://www.worldenergyoutlook.org/resources/energydevelopment/energyaccessdatabase>.
- [2] International Energy Agency. World Energy Outlook 2016, 2016.
- [3] Sustainable Energy for All. Global Tracking Framework, 2014.
- [4] S. Ahmad, M. Mathai, and P. Govindan. Household Electricity Access, Availability and Human Well-being: Evidence from India. *Energy Policy*, 69:308–315, March 2014.
- [5] U. Chakravorty, M. Pelli, and B. Marchand. Does the Quality of Electricity Matter? Evidence from Rural India. *Journal of Economic Behavior and Organization*, 107:228–247, April 2014.
- [6] M. Kanagawa and T. Nakata. Assessment of Access to Electricity and the Socio-economic Impacts in Rural Areas of Developing Countries. *Energy Policy*, 36:2016–2029, 2008.
- [7] J. Goldemberg, T. Johansson, A. Reddy, and R. Williams. Basic Needs and Much More With One Kilowatt Per Capita. *Ambio: A Journal of the Human Environment*, 1985.
- [8] United Nations. Sustainable Development Goals, 2016. Available online at <http://www.un.org/sustainabledevelopment/sustainable-development-goals>.
- [9] Douglas Ellman. The Reference Electrification Model: A Computer Model for Planning Rural Electricity Access. Master’s thesis, MIT, 2015.
- [10] Yael Borofsky. Toward a Transdisciplinary Approach to Rural Electrification Planning for Universal Access in India. Master’s thesis, MIT, 2015.
- [11] Vivian Li. The Local Reference Electrification Model: A Comprehensive Decision-Making Tool for the Design of Rural Microgrids. Master’s thesis, MIT, 2016.
- [12] Patricia Levi. Feasibility of Grid Compatible Microgrids. Master’s thesis, MIT, 2016.

- [13] Pedro Ciller Cutillas. Clustering-related Improvements in the Reference Electrification Model. Master’s thesis, Institute for Research in Technology, Comillas Pontifical University, 2015.
- [14] C. Domingo, T. Román, Á. Sánchez-Miralles, J. González, and A. Martínez. A Reference Network Model for Large-Scale Distribution Planning with Automatic Street Map Generation. *IEEE Transactions on Power Systems*, 26, February 2011.
- [15] Sanusi Ohiare. Expanding Electricity Access to All in Nigeria: A Spatial Planning and Cost Analysis. *Energy, Sustainability and Society*, 5:8, 2015.
- [16] R. Fronius and M. Gratton. Rural Electrification Planning Software (Laper). *Electricité de France - Research and Development*, 2001. Available online at http://www.cired.net/publications/cired2001/5_20.pdf.
- [17] Cara Goman. Global Microgrid Market to Reach \$35.1b by 2020 and Other Quick Microgrid News, January 2016. Available online at <http://microgridknowledge.com/global-microgrid-market/>.
- [18] Microgrids at Berkeley Lab. Microgrid Definitions, 2017. Available online at <https://building-microgrid.lbl.gov/microgrid-definitions>.
- [19] P. Maithani and D. Gupta. *Achieving Universal Energy Access in India: Challenges and the Way Forward*. SAGE Publications India Pvt Ltd, 2015.
- [20] P. Balachandra. Dynamics of Rural Energy Access in India: An Assessment. *Energy*, 36:5556–5567, August 2011.
- [21] S. Pachauri. Reaching an International Consensus on Defining Modern Energy Access. *Current Opinion in Environmental Sustainability*, 3:235–240, 2011.
- [22] International Energy Agency. World Energy Outlook 2016: Methodology for Energy Access Analysis, 2016. Available online at http://www.worldenergyoutlook.org/media/weowebiste/energymodel/documentation/EnergyAccess_Methodology_2016.pdf.
- [23] Central Intelligence Agency. Country Comparison: Electricity Consumption. Available online at <https://www.cia.gov/library/publications/the-world-factbook/rankorder/2233rank.html>.
- [24] Energy Sector Management Assistance Program. Beyond Connections: Energy Access Redefined, July 2015.
- [25] C. Elvidge et al. Who’s in the Dark—Satellite Based Estimates of Electrification Rates. *Urban Remote Sensing: Remote Sensing: Monitoring, Synthesis and Modeling in the Urban Environment*, 2011.

- [26] T. Ghosh et al. Shedding Light on the Global Distribution of Economic Activity. *The Open Geography Journal*, 3:148–161, 2010.
- [27] J. Henderson et al. Measuring Economic Growth from Outer Space. *American Economic Review*, 102(2):994–1028, 2012.
- [28] C. Doll and S. Pachauri. Estimating Rural Populations without Access to Electricity in Developing Countries through Night-time Light Satellite Imagery. *Energy Policy*, 38:5661–5670, 2010.
- [29] C. Doll. Population Detection Profiles of DMSP-OLS Night-time Imagery by Regions of the World. *Proceedings of the Asia-Pacific Advanced Network*, 30:190–206, 2010.
- [30] B. Min et al. Detection of Rural Electrification in Africa Using DMSP-OLS Night Lights Imagery. *International Journal of Remote Sensing*, 34(22):8118–8141, 2013.
- [31] B. Min and K. Gaba. Tracking Electrification in Vietnam Using Nighttime Lights. *Remote Sensing*, 6:9511–9529, 2014.
- [32] K. Lee et al. Electrification for Under Grid Households in Rural Kenya. *Development Engineering*, 2015.
- [33] Uganda Bureau of Statistics. The National Population and Housing Census 2014, 2016.
- [34] Consolidated Edison Company of New York. Distributed System Implementation Plan, June 2016.
- [35] V. Levi and M. Calovic. Linear-programming-based Decomposition Method for Optimal Planning of Transmission Network Investments. *IEEE Proceedings-C*, 140(6), November 1993.
- [36] A. Soroudi and M. Ehsan. A Distribution Network Expansion Planning Model Considering Distributed Generation Options and Techno-economical Issues. *Energy*, 35, 2010.
- [37] E. Gutiérrez, T. Gómez, Á. Sánchez, and J. Vicente. ANDREA: A Long-Term Dynamic Planning Tool for Subtransmission Electricity Networks. *Energy Market, 2009. EEM 2009. 6th International Conference on the European*, 2009.
- [38] I. Abdelmottaleb, T. Gómez, and J. Reneses. Distribution Network Cost Allocation Using a Locational and Temporal Cost Reflective Methodology. *Power Systems Computation Conference*, June 2016.
- [39] Ashwini Bharatkumar. Distribution Network Use-of-System Charges Under High Penetration of Distributed Energy Resources. Master’s thesis, MIT, 2015.
- [40] MIT Energy Initiative. Utility of the Future, 2016. Available online at energy.mit.edu/uof.

- [41] P. Alstone, D. Gershenson, and D. Kammen. Decentralized Energy Systems for Clean Electricity Access. *Nature Climate Change*, 5:305–314, April 2015.
- [42] R. Bellanca, E. Bloomfield, and K. Rai. *Delivering Energy for Development: Models for Achieving Energy Access for the World’s Poor*. Practical Action Publishing, 2013.
- [43] C. Greacen, R. Engel, and T. Quetchenbach. A Guidebook on Grid Interconnection and Islanded Operation of Mini-Grid and Power Systems Up to 200 kW, April 2013.
- [44] Africa Progress Panel. Lights Power Action: Electrifying Africa, March 2017. Available online at http://www.africaprogresspanel.org/wp-content/uploads/2017/03/APP_Lights_Power_Action_Web_PDF.pdf.

Appendix A

Regional REM Input File Descriptions

This appendix describes the input file structures necessary to run a case with REM. It has been adapted from a more detailed description written by Claudio Vergara.

A.1 Equipment Catalog

Distribution Lines

Field	Units	Description
name		unique name for each catalog entry
resistance	Ω/km	50 Hz resistance per unit length of the single-line equivalent circuit
reactance	Ω/km	50 Hz reactance per unit length of the single-line equivalent circuit
number of phases		number of phases in the line
nominal current	A	maximum current that can be carried by the line because of thermal constraints under reference dissipation conditions
overload	p.u.	multiple of the maximum current that can be carried by the line during short periods of time
voltage	V	rated potential different between phases in a three-phase circuit
failure rates	$\frac{failure}{year*km}$	description of the tendency of the line to fail in a way that it needs to be repaired
investment cost	$\frac{USD}{km}$	overnight cost of building the line, including materials and installation

preventive maintenance cost	$\frac{USD}{year*km}$	cost of routine maintenance operations
Corrective maintenance cost	$\frac{USD}{failure}$	cost of repairing the line each time it fails

Transformers

Field	Units	Description
name		unique name for each catalog entry
rated power	kVA	apparent power that can be transferred from the primary circuit
secondary voltage	V	rated voltage of the lower voltage winding of the transformer
primary voltage	V	rated voltage of the higher voltage winding of the transformer
no-load losses	W	power consumption of the transformer when the primary winding is at rated voltage and no current is flowing out of the secondary winding
low-voltage DC resistance	Ω	measured resistance of the secondary winding by means of a direct-current injection
maximum number of outlets		maximum number of circuits that can be connected to the low-voltage side of the transformer
outlet cost	USD	cost of each additional outlet
failure rates	$\frac{failure}{year}$	description of the tendency of the transformer to fail in a way that it needs to be repaired
investment cost	USD	overnight cost of placing the transformer, including materials and installation
preventive maintenance cost	$\frac{USD}{year}$	cost of routine maintenance operations
corrective maintenance cost	$\frac{USD}{failure}$	cost of repairing the line each time it fails

AC/DC Converters

Field	Units	Description
name		unique name for each catalog entry
rated power	kW	maximum active power that can be transferred through the converter
investment cost	USD	cost of purchasing the inverter
lifetime	year	financial lifetime of the asset

inverter efficiency	p.u.	efficiency of transferring power from the DC to the AC bus
rectifier efficiency	p.u.	efficiency of transferring power from the AC to the DC bus
installation cost factor	p.u.	installation cost expressed as a fraction of the investment cost
operation and maintenance factor	p.u.	operation and maintenance cost expressed as a fraction of the investment cost; this includes materials, not labor
operation and maintenance hours	$\frac{\text{hour}}{\text{year}}$	number of hours of labor that are dedicated to operate and maintain the device

Charge Controllers

Field	Units	Description
name		unique name for each catalog entry
rated power	kW	maximum active power that can be transferred through the converter
investment cost	USD	cost of purchasing the charge controller
lifetime	year	financial lifetime of the asset
efficiency	p.u.	efficiency of transferring power through the converter
installation cost factor	p.u.	installation cost expressed as a fraction of the investment cost
operation and maintenance cost factor	p.u.	operation and maintenance cost expressed as a fraction of the investment cost. This includes materials, not labor
operation and maintenance hours	$\frac{\text{hour}}{\text{year}}$	number of hours of labor that are dedicated to operate and maintain the device

Internal Combustion Engine Generator

Field	Units	Description
name		unique name for each catalog entry
rated power	kW	maximum active power that can be generated
$\frac{1}{4}$ load burn rate	$\frac{L}{kWh}$	fuel consumption per kWh of electric power delivered at 25% of the rated power
$\frac{1}{2}$ load burn rate	$\frac{L}{kWh}$	fuel consumption per kWh of electric power delivered at 50% of the rated power

$\frac{3}{4}$ load burn rate	$\frac{L}{kWh}$	fuel consumption per kWh of electric power delivered at 75% of the rated power
no load burn rate	$\frac{L}{h}$	fuel consumption per kWh of electric power delivered at rated power
minimum power	kW	minimum power output of the generator when turned on
start time	hour	time that the generator has to be operated at no-load before it can start delivering electric power
stop time	hour	time that the generator has to be operated at no-load after it has stopped delivering electric power
lifetime	hour	the generator has to be replaced after this time in operation
investment cost	USD	cost of purchasing the ICE generator
operation and maintenance cost	$\frac{USD}{year}$	maintenance cost of the ICE corresponding to materials
maintenance time	hour	number of hours of labor that are dedicated to operate and maintain the device

Photovoltaic Generators

Field	Units	Description
name		unique name for each catalog entry
rated power	kW	DC power output under nominal irradiance and temperature conditions at the beginning of life
investment cost	USD	cost of purchasing one solar panel
installation cost factor	p.u.	installation cost expressed as a fraction of the investment cost
operation and maintenance cost factor	p.u.	operation and maintenance cost expressed as a fraction of the investment cost; this includes materials, not labor
operation and maintenance hours	$\frac{hour}{year}$	number of hours of labor that are dedicated to operate and maintain the device
capacity loss	$\frac{p.u.}{year}$	decrease in the output under nominal conditions because of aging, as a fraction of the rated power

Batteries

Field	Units	Description
name		unique name for each catalog entry
investment cost	USD	purchase cost for one battery unit
end of life energy capacity	p.u.	fraction of the nominal energy capacity that is available when the battery has reached the end of life
installation cost factor	p.u.	installation cost expressed as a fraction of the investment cost
operation and maintenance cost factor	p.u.	operation and maintenance cost expressed as a fraction of the investment cost; this includes materials, not labor
operation and maintenance hours	$\frac{\text{hour}}{\text{year}}$	number of hours of labor that are dedicated to operate and maintain the device
nominal energy capacity	kWh	theoretical amount of energy that can be delivered by a fully charged battery at 1 C discharge rate under standard conditions
maximum discharge capacity	A	absolute maximum rate at which the battery can deliver charge, independent of the state
maximum charge current	A	absolute maximum rate at which the battery can receive charge, independent of the state
rated voltage	V	reference potential difference, which is close to what one would measure at state of charge 0.5
lifetime throughput	kWh	amount of energy that the battery can deliver before reaching its end of life
kibam c	p.u.	defines the ratio between the bound and available capacities of a battery in the kinetic battery model
kibam k	p.u.	diffusive charge transfer coefficient in the kinetic battery model

A.2 Local Information

Buildings

Field	Units	Description
ID		unique identifier of each building
x coordinate, y coordinate	m	location of the buildings in a rectangular reference frame (UTM)

customer type name		qualitative description of the consumer (e.g., residential, school, etc.)
customer type		associates the building with a set of similar electricity consumption profiles
customer sub-type		associates the building with a specific consumption profile within the set corresponding to its type
electrification status		denotes whether the building is currently electrified

Existing Distribution Network

Field	Units	Description
name		unique identifier of the network section
voltage level		qualitative classification into high voltage (HV), medium voltage (MV) and low voltage (LV)
energy cost	$\frac{USD}{kWh}$	variable cost of the electricity consumed from the segment
reliability profile	p.u.	vector of 24 components which is interpreted as the fraction of the time, calculated over one year, that electricity supply would be available to a consumer connected to the line segment

Solar Resource

Field	Units	Description
hour		vector of 8760 values corresponding to the hours of the year
DC factor	kW	expected production of a properly installed 1 kW peak solar panel on the location at the maximum power point, before the MPPT

Load Profiles

Field	Units	Description
hour		vector of 8760 values corresponding to the hours of the year
high priority load	kW	high priority demand for each hour of the year for subtypes 1 to n

low priority load	kW	low priority demand for each hour of the year for subtypes 1 to n
-------------------	----	---

Load Profiles Decomposition

The load profile of each building in the dataset is defined as a linear combination of fundamental load profiles, which we call *demand patterns*. If the option is selected in **User Options**, the defined load profiles are used as base references, and the profile of each actual user type is calculated using the information in this file.

This file contains a matrix whose rows are related to customer types and whose columns are related to basic demand patterns. This implies that the demand profile of the customer of the i -th row is calculated by multiplying each demand pattern by the coefficient of that row, which needs to be an integer, and then adding them.

Generation Look-up Table Coordinates

One of the clustering algorithms within the model makes use of multi-axis look-up tables to approximate the cost of generation during the clustering process. This file contains the points of the look-up table that REM uses to calculate accurate off-grid generation designs, as integer multiples of the base demand profiles. Beyond the last point of each axis, REM assumes that there are no economies of scale.

Terrain Elevation

This file¹ corresponds to a matrix (i.e. raster map) with the following meta-data. Note that the value on each cell of the matrix corresponds to the altitude, in meters above the mean sea level, of the center of the cell.

Field	Description
ncols	number of columns in the raster map
nrows	number of rows in the raster map
xllcorner	horizontal coordinate of the lower left corner of the raster map in the rectangular reference frame
yllcorner	vertical coordinate of the lower left corner of the raster map in the rectangular reference frame

¹Refer to Cailinn Drouin's thesis (to be published) for additional insight on designing electrical networks with topography constraints.

cellsize	horizontal and vertical size of the cells in the raster map
NODATA_value	value used to indicate missing data for cells in the raster

Penalized Areas

This set of files characterizes zones in the map where building and maintaining network infrastructure is more difficult than usual.

Field	Description
FACTOR_CINV	penalty multiplier applied to the investment cost of network equipment within the polygon
FACTOR_CMANP	penalty multiplier applied to the preventive maintenance cost of network equipment within the polygon
FACTOR_CMANC	penalty multiplier applied to the corrective maintenance cost of network equipment within the polygon
NAME	unique identifier of the polygon
TYPE	generic identifier of the type of polygon (e.g. lake, reservation, wetland)

Village Boundaries

It is possible to bias REM to have a tendency to make buildings which lay within administrative boundaries part of the same electrification sub-project by providing a KML file with polygons defining the boundaries.

A.3 User Options

Field	Units	Description
name of the region		label for the region under study
name of the case study		label for the particular case study
cost of energy losses in micro-grids	$\frac{USD}{kWh}$	valuation of energy losses in microgrids, used to design a distribution network with RNM
cost of energy losses in grid extensions	$\frac{USD}{kWh}$	valuation of energy losses in grid extensions, used to design a distribution network with RNM
diesel fuel cost	$\frac{USD}{liter}$	cost of the fuel used by ICE generators
user power factor	p.u.	inductive power factor of all the consumers

demand growth rate	p.u.	annual increase in demand profiles, applied as a compound multiplier
reference year for the design	year	defines the design horizon; off-grid systems will meet the load in that year
minimum demand fraction for off-grid systems	p.u.	only designs that serve more than this fraction of the yearly energy demand will be considered by the model
number of periods for off-grid supply design		when searching for the best design, the model will simulate this number of periods within a year
duration of each period for off-grid supply design	hour	each one of the periods used for simulation will have this number of hours
clustering algorithm		selects which clustering algorithm will be use; the valid options are sequential and simultaneous
dispatch algorithm		selects which operation simulation algorithm will be used; currently only 1 is supported by the model
consider penalized zones		use the penalized zones cost multipliers
consider village boundaries		the model will have a tendency to group together buildings within the same village boundary
consider terrain		take into account the elevation raster for the length and cost of distribution networks
cost of low-priority non-served energy	$\frac{USD}{kWh}$	this penalty will be added when some amount of low-priority demand is not met
cost of high-priority non-served energy	$\frac{USD}{kWh}$	this penalty will be added when some amount of high-priority demand is not met
user profiles from base profiles		express load profiles as a linear combination of base profiles
discount rates by system type	p.u.	vector of three components corresponding to the cost of capital for 1) grid extension, 2) microgrids, and 3) standalone systems
distribution network cost factor	p.u.	estimation of the fractional losses in microgrid distribution networks
load voltage	kV	nominal connection voltage of all the consumers
grid extension lifetime	year	financial lifetime of grid extension infrastructure
microgrid network lifetime	year	financial lifetime of microgrid network infrastructure
per-customer cost in grid extensions	USD	costs incurred which are proportional to the number of consumers in the system
per-customer cot in microgrids	USD	costs incurred which are proportional to the number of consumers in the system
per-customer cost in standalone systems	USD	costs incurred for each building, independent from local supply costs

lifetime of per-customer investments	year	financial lifetime of these investments, used to calculate annuities
number of customers in typical systems		this field is used to compute a curve which reflects economies of scale in management costs; the two values in the vector correspond to 1) a small system and 2) a medium-sized system
per-customer management cost in systems of different sizes		vector of 3 components with per-customer management cost for 1) small, 2) medium, and 3) large systems
electricity supply profile		this field includes 24 values which can be used to shut off the demand of all users during certain hours of each day
operation and maintenance time for different off-grid supply system types	hour	the vector contains 8 values for different combinations of off-grid supply equipment

Appendix B

Regional REM Output File Descriptions

This appendix describes the output file structures produced in a case using REM. It has been adapted from a more detailed description written by Claudio Vergara.

B.1 Results Summary for Entire Case

Each entry on the table corresponds to an independent project within the case.

Field	Units	Description
name		unique identifier of the project
type		type of project
cluster type		type of cluster that was evaluated and selected for the electrification mode
number of users		variable cost of the electricity consumed from the segment
grid energy	$\frac{kWh}{year}$	energy consumed from the distribution network every year
grid energy cost	$\frac{USD}{year}$	amount paid every year for the energy consumed from the grid
PV installed capacity	kW	rated power of the PV array
PV annuity	$\frac{USD}{year}$	annuitized cost of the PV panel including O&M
BESS energy	kWh	rated battery system capacity
BESS annuity	$\frac{USD}{year}$	annuitized cost of the battery including O&M and replacement
ICE power	kW	rated installed capacity of internal combustion engine generation

ICE annuity	$\frac{USD}{year}$	annuitized cost of the ICE, including O&M
fuel	$\frac{L}{year}$	annual fuel consumption
fuel annual cost	$\frac{USD}{year}$	annual fuel expenditure
high priority non-served energy	$\frac{kWh}{year}$	amount of high priority non-served energy
low priority non-served energy	$\frac{kWh}{year}$	amount of low priority non served energy
peak demand	kW	maximum consumption
demand	kWh	yearly energy demand

B.2 Microgrid Cash Flow

Each row corresponds to a single year.

Field	Units	Description
year		relative year since the start of the project
total expenses	USD	total amount expensed in the year
PV	USD	purchase and installation of solar panels
ICE	USD	purchase and installation of ICE
BESS	USD	purchase and installation of BESS
inverter	USD	purchase and installation of inverters
MPPT	USD	purchase and installation of MPPT
network	USD	overnight network cost
management	USD	cost of managing the system
supply O&M	USD	operation and maintenance costs related to the energy supply system
network O&M	USD	operation and maintenance costs related to the network
fuel	USD	fuel expenditure of the ICE

B.3 Grid Extension Cash Flow

Each row corresponds to a single year.

Field	Units	Description
year		relative year since the start of the project
total expenses	USD	total amount expensed in the year

network	USD	overnight network cost
management	USD	cost of managing the system
grid energy	USD	expenditure in energy purchased from the main grid
network O&M	USD	operation and maintenance costs related to the network

B.4 Isolated System Cash Flow

Each row corresponds to a single year.

Field	Units	Description
year		relative year since the start of the project
total expenses	USD	total amount expensed in the year
PV	USD	purchase and installation of solar panels
ICE	USD	purchase and installation of ICE
BESS	USD	purchase and installation of BESS
inverter	USD	purchase and installation of inverters
MPPT	USD	purchase and installation of MPPT
management	USD	cost of managing the system
supply O&M	USD	operation and maintenance costs related to the energy supply system
fuel	USD	fuel expenditure of the ICE

B.5 Microgrid Dispatch

Each row corresponds to a single year.

Field	Units	Description
demand	kWh	potential energy consumption
PV generation	kWh	energy produced by the PV generator
maximum PV generation	kWh	potential production of the PV generator
ICE generation	kWh	energy produced by the ICE generator
low-priority non-served energy	kWh	amount of low-priority potential energy consumption that was not met
high-priority non-served energy	kWh	amount of high-priority potential energy consumption that was not met
battery discharge	kWh	energy injected by the battery

battery charge	kWh	energy extracted by the battery
ICE state		indicates whether the ICE is on
losses	kWh	total amount of losses in the system
non-network losses	kWh	losses in the supply system
battery state of charge	p.u.	battery state of charge

B.6 Network Files

Shapefiles of necessary distribution transformers and low- and medium-voltage lines to construct for each project.